



12' X 10'

HARDTOP GAZEBO

ARTICLE # 254273

ASSEMBLY INSTRUCTIONS

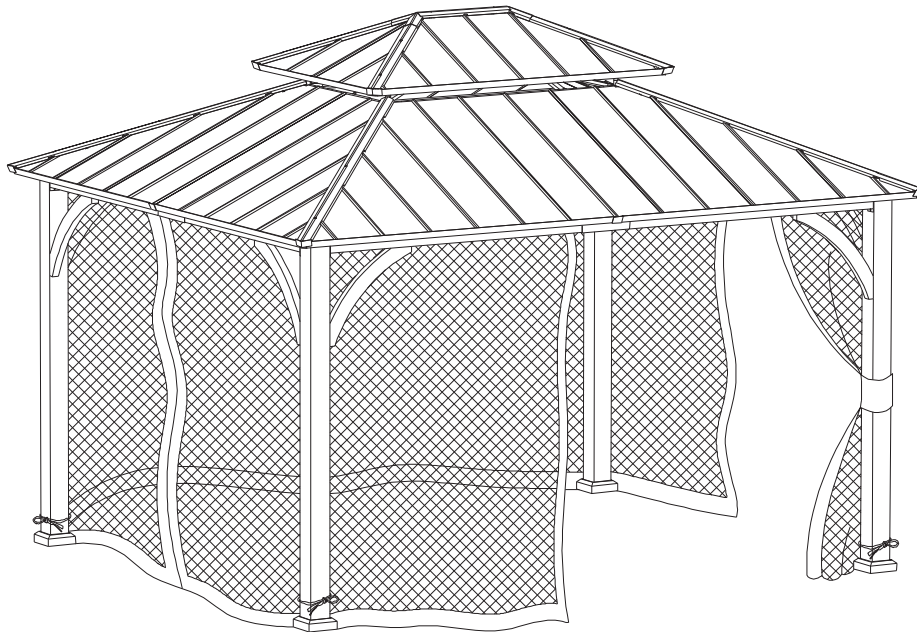

Note: The gazebo needs to be installed in cooperation with four people. The following tools are not included and needed for assembly:



Drill

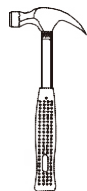

Hammer



Screwdriver



Ladder

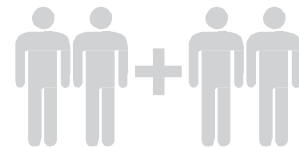

4 people

If you have comments or questions, please contact BJ's Wholesale Club at 1-800-934-1204.

Carefully check all packaging materials before discarding.

Make sure you have all the parts and hardware as identified on the parts list.

Do not assemble if there are missing pieces.

For any questions, replacement parts or issues about our product, contact Sunjoy Customer Service at 1-866-578-6569 or email bj@sunjoygroup.com.











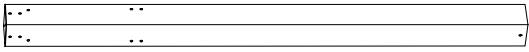

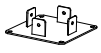
Important Safety Instructions

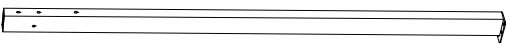

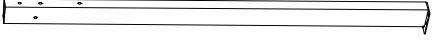
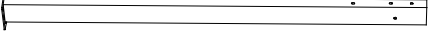
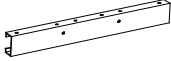
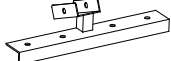



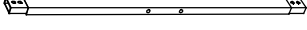
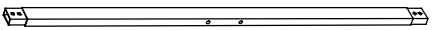

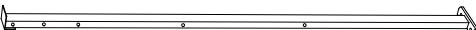





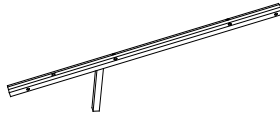



Warning! To reduce the risk of serious injury, read the following safety instructions before assembling and using the gazebo.









Caution! Always keep children under close supervision while they are using or around this product. Never leave children unattended.

- This product is intended for outdoor use only.
- The product should be assembled on a flat stable surface.
- Do not assemble the gazebo on unstable surfaces.
- Ensure the location and clearance of your gazebo is acceptable.
- The gazebo must be anchored with stakes into the ground for added safety. It is recommended that it should not be permanently attached to a concrete floor or platform.
- Arrange the necessary manpower when assembling or moving the product.
- Some parts may contain sharp edges. Wear protective gloves and glasses if necessary.
- Keep children and pets away while setting up the gazebo.
- Check all nuts and bolts periodically for tightness. When required, tighten them again.
- Repairing and replacing parts should be done by a qualified technician.
- The gazebo is intended for decorative and shade purposes only, and is not designed to withstand harsh weather, including high winds, rain and snow.
- If the product is not being used for long periods of time (e.g. winter), it should be stored in a clean, dry environment.
- Do not put a Liquid Propane or Wood Burning fire pit or fireplace inside the product.
- Do not climb or place heavy objects onto the gazebo roof.
- Retain the original packaging to store and protect the gazebo during the winter months.
- Do not use or enter the gazebo if the following conditions exist:
 1. Visible movement of supports, roofing panels or a sagging roof.
 2. Unusual noise from the gazebo.
 3. Deformed roof panels.
 4. Damaged or missing bolts/fasteners.
- Please check your HOA, Local, and State Governments prior to purchasing and assembling gazebos. These local organizations may require permits and specific requirements for installation.
- Maintain your instruction manual for future reference
- Warranty: Please retain your receipt for proof of purchase.

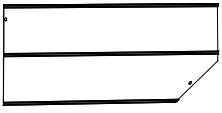
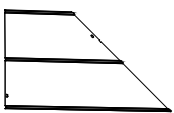
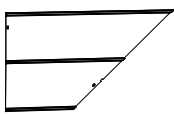

Part List

Description	Label	Part Number	Qty	Part Image
Post	A	P000200570	4	
Stake cover	B	P006100210	4	
Stake base	C	P000100409	4	
Bottom oblique bar connector	D	P00050024901	4	
Left long cross beam	E	P000401106	2	
Right long cross beam	F	P000401107	2	
Left short cross beam	G	P000401104	2	
Right short cross beam	J	P000401105	2	
Cross beam connector	K	P000501534	4	
Bottom middle bar connector	L	P000501533	4	
Cross beam middle panel	M	P005600441	4	
Curve support	N	P005000545	8	
Curve support panel	P	P000501535	16	
Top roof short bar	Q	P00050157301	2	
Top roof long bar	R	P00050156801	2	
Top roof corner	S	P00050157501	4	
Oblique bar	T	P00060197101	4	
Middle bar	U	P00060198301	4	

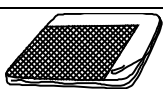
Mosquito netting bar 1	V	P00570034501	2	
Mosquito netting bar 2	W	P00570034601	2	
Mosquito netting bar 3	X	P00570034701	2	
Mosquito netting bar 4	Y	P00570034801	2	
Small roof connector	AA	P00050156301	1	
Small roof oblique bar	AB	P00060023601	4	
Hook	AC	P005800001	1	
Small roof short edge bar	AD	P00060202101	2	
Small roof long edge bar	AE	P00060202301	2	
Small roof panel 1	AF	P00070022401	4	
Small roof panel 2	AG	P00070022501	2	
Small roof panel 3	AJ	P00070022601	4	
Small roof oblique bar cover	AK	P00080009801	4	
Small roof top cover	AL	P00090004001	1	
Big roof short bar 1	AM	P00060198901	4	
Big roof short bar 2	AN	P00060199901	4	
Big roof long bar 1	AP	P00060199001	4	
Big roof long bar 2	AQ	P00060200001	4	
Big roof short bar 3	AR	P00060201201	2	

Big roof short bar 4	AS	P00060201601	2	
Big roof long bar 3	AT	P00060201301	2	
Big roof long bar 4	AU	P00060201701	2	
Big roof panel 1	AV	P00070103501	2	
Big roof panel 2	AW	P00070102101	4	
Big roof panel 3	AX	P00070102601	4	
Big roof panel 4	AY	P00070101401	4	
Big roof panel 5	BA	P00070101601	4	
Big roof panel 6	BB	P00070101001	4	
Big roof panel 7	BC	P00070101201	4	
Big roof oblique bar cover	BD	P00080034401	4	
Mosquitonetting	BE	P001200263	1	

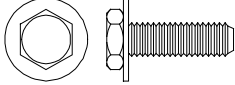
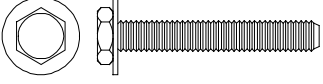
Hardware Pack

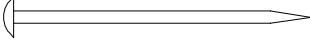
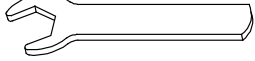
H1	Bolt M6*20	H100010047	338+17	
H2	Bolt M6*40	H100010046	12+1	
HR	Ring	P005100264	52+3	
HS	Stake $\Phi 8 \times 180$	H070010003	8	
HW	Wrench M6	H090010017	1	

1

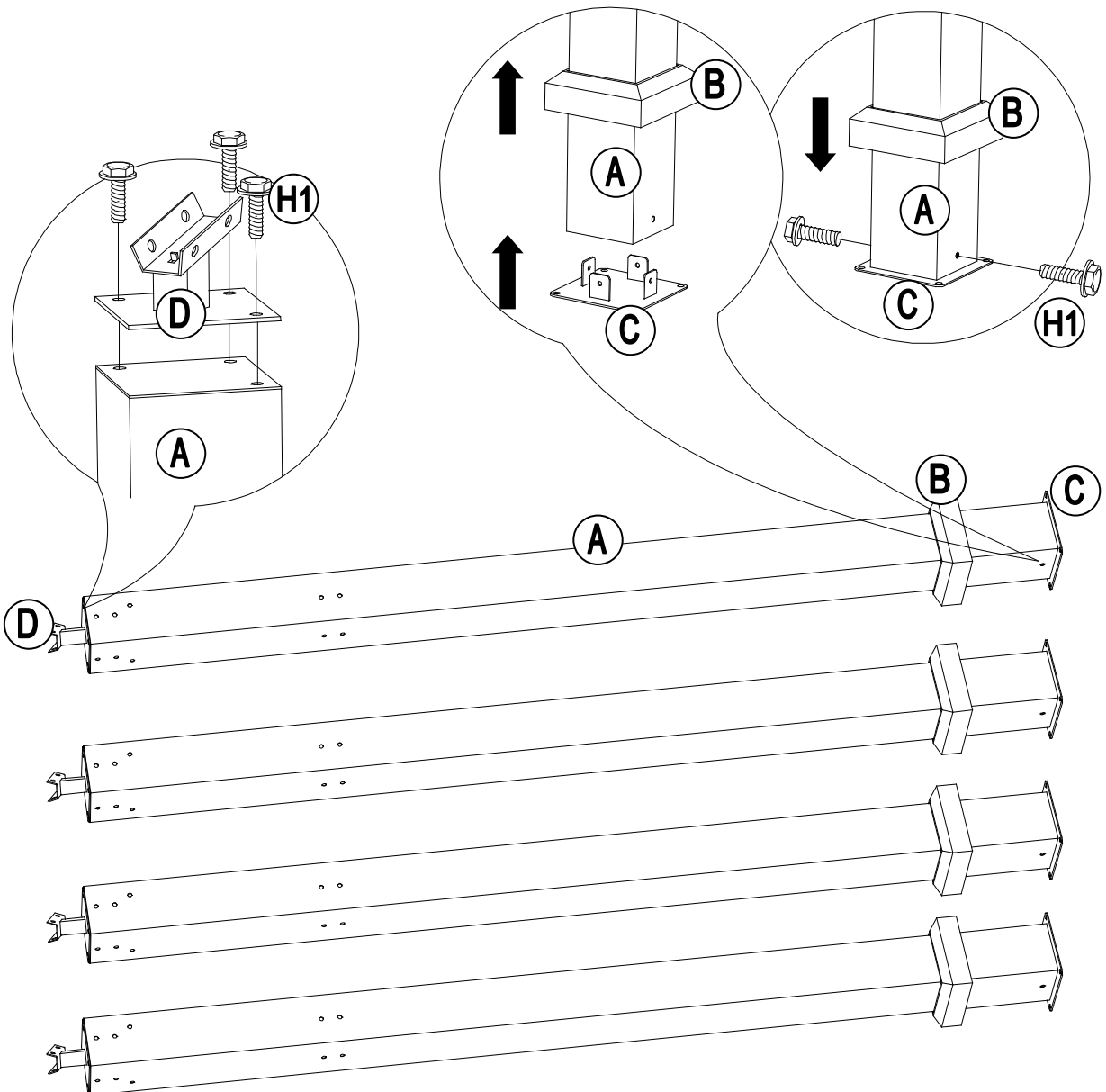
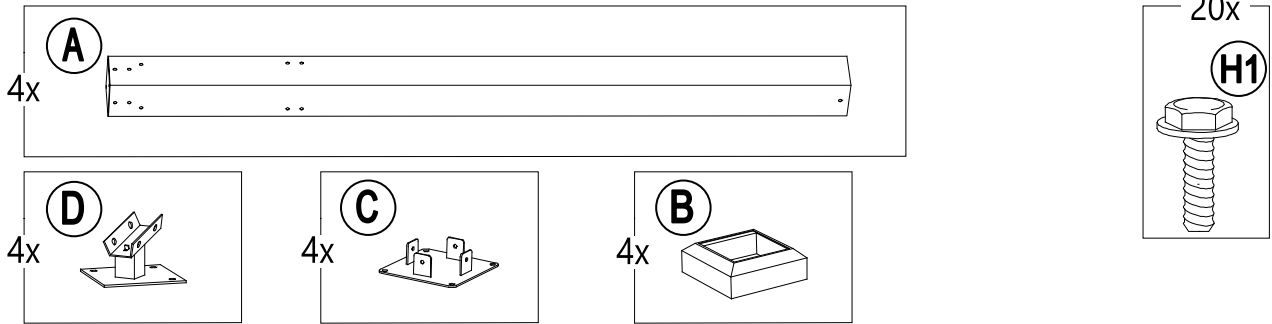

2

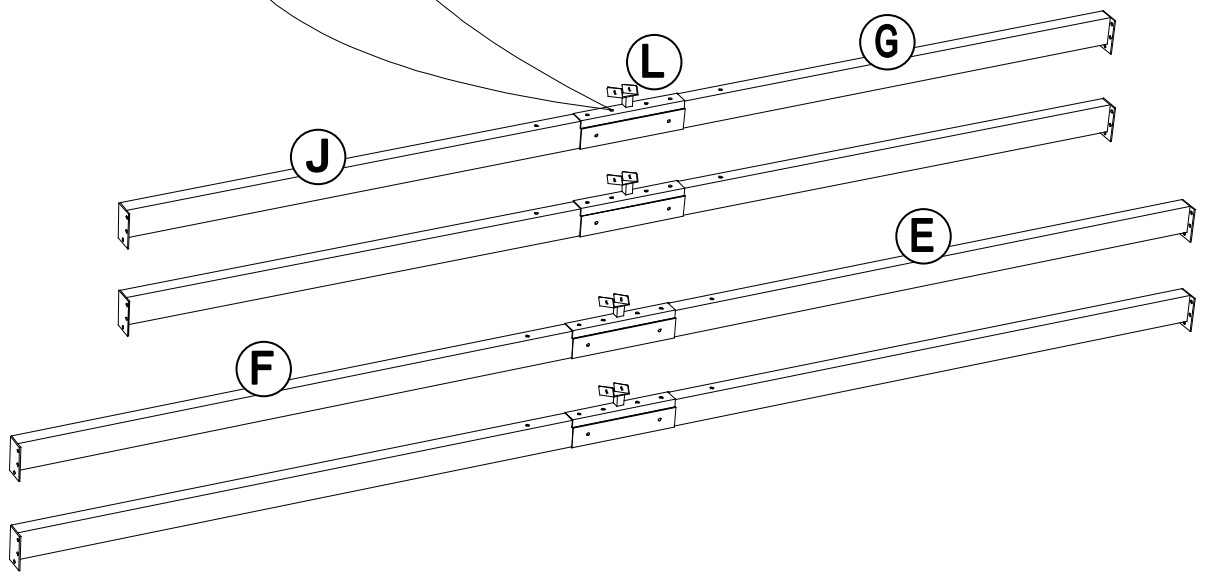
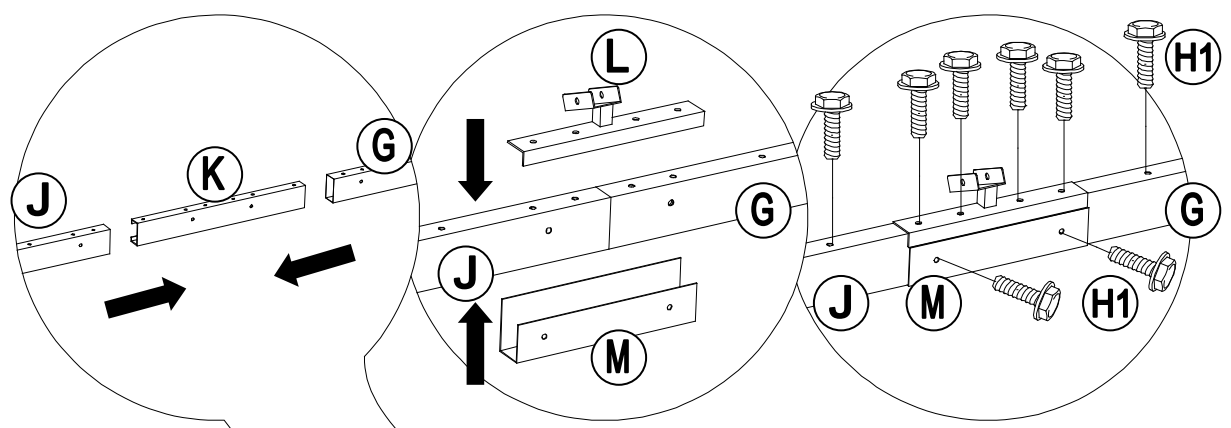
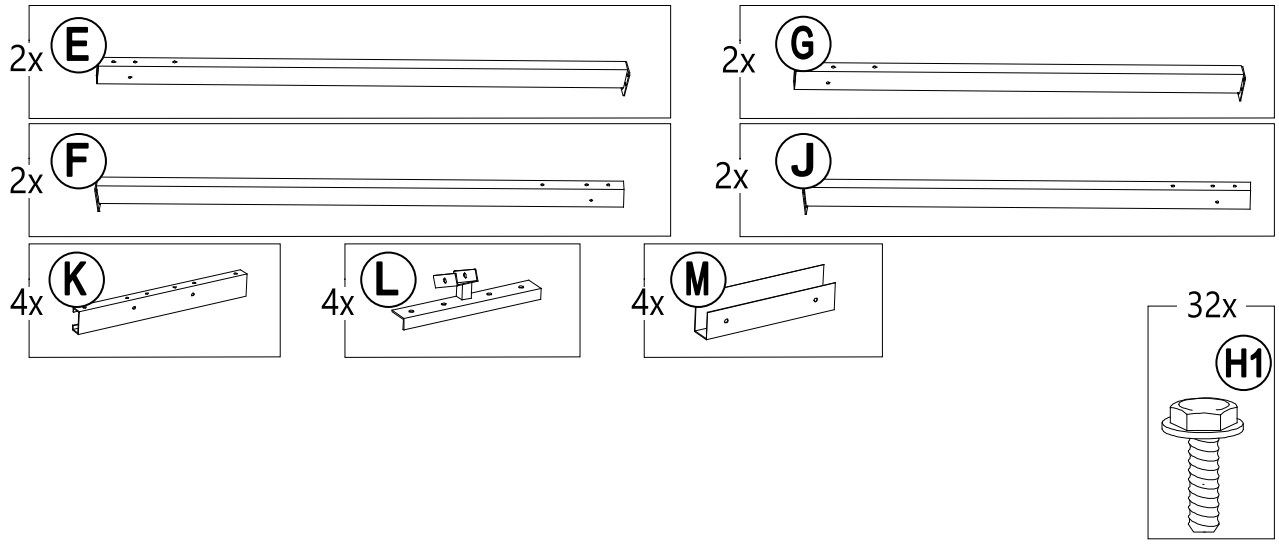

3

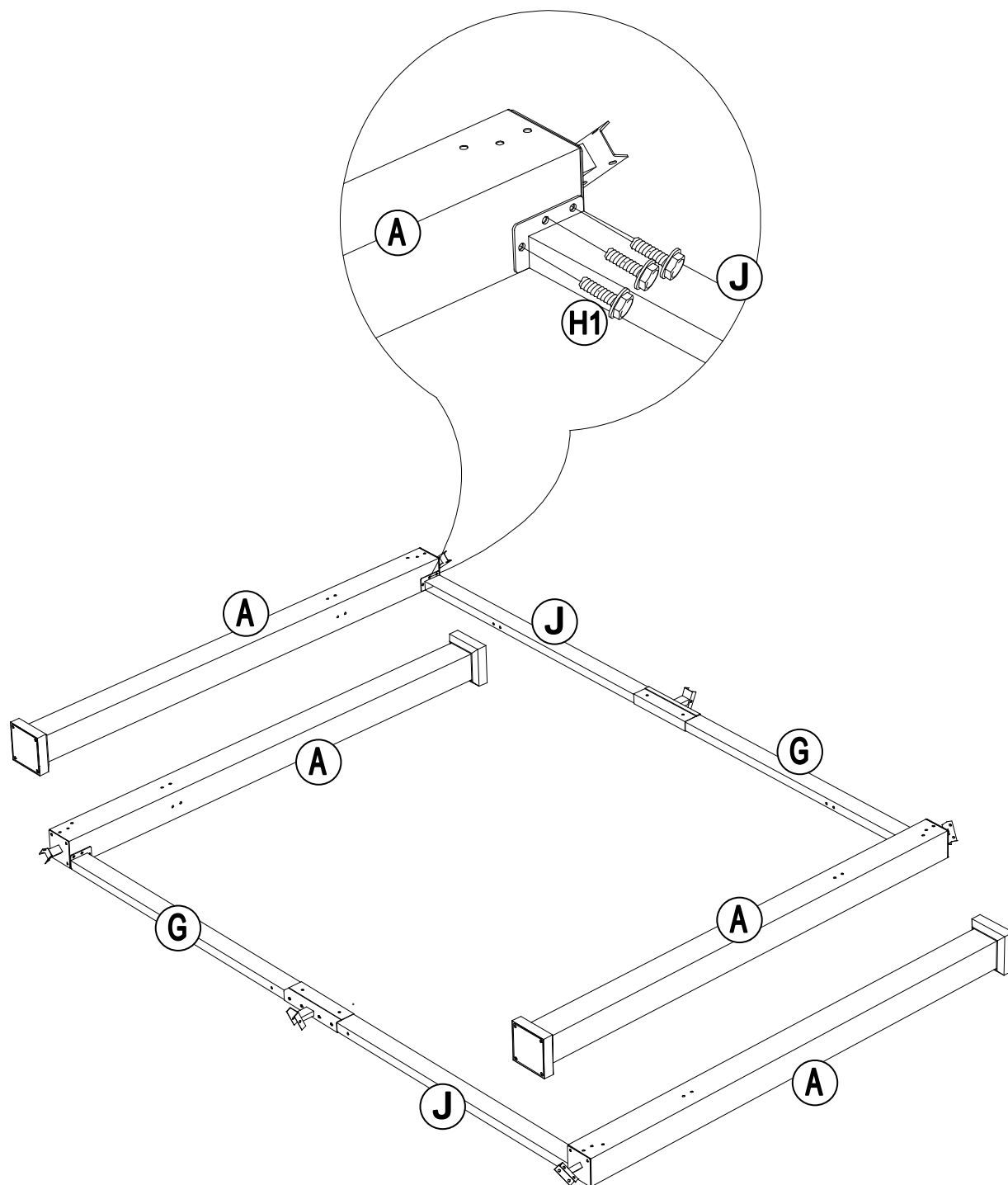
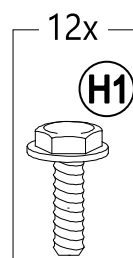
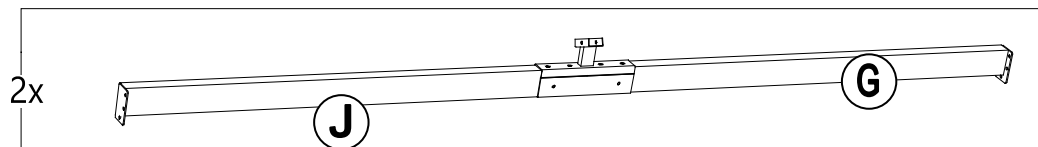

4

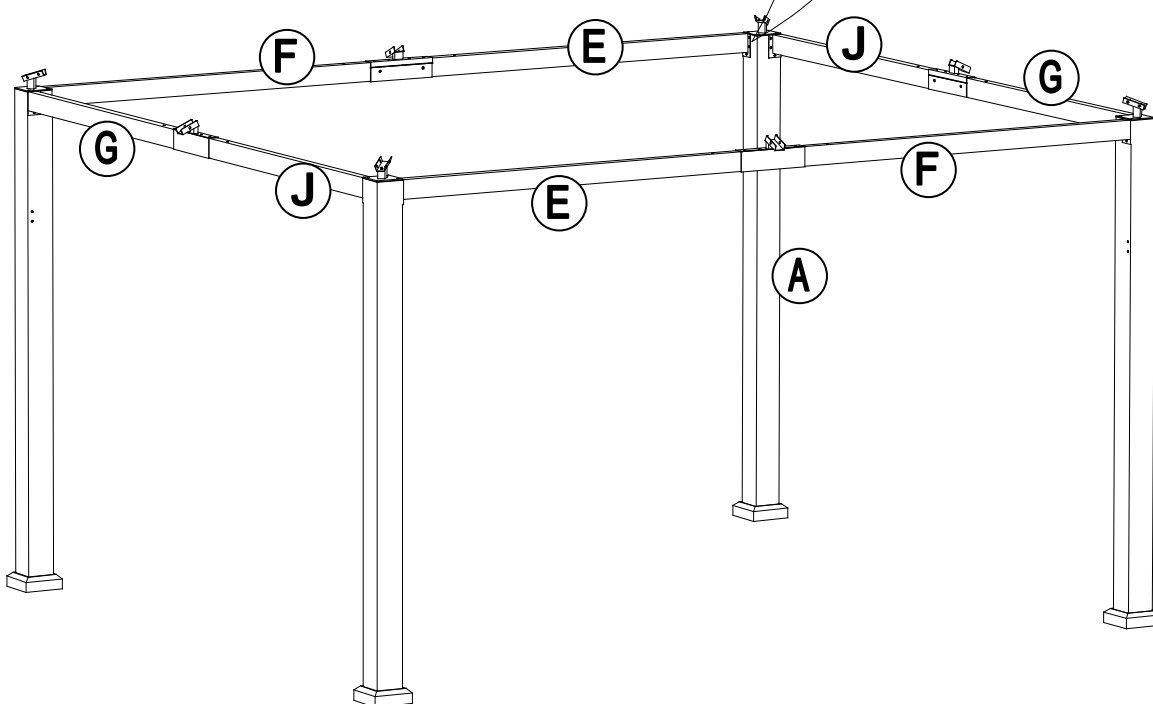
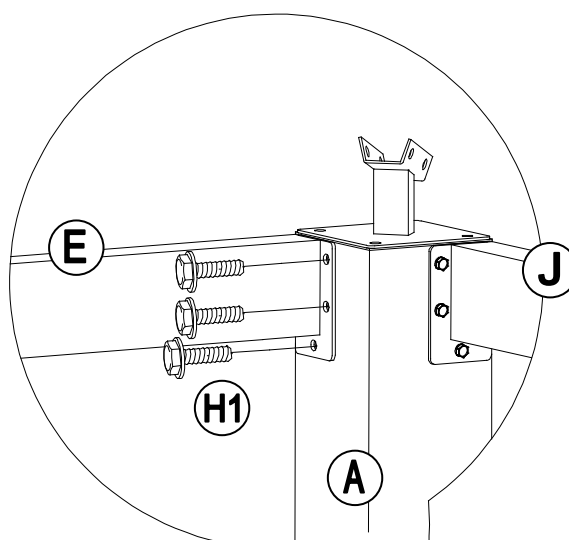
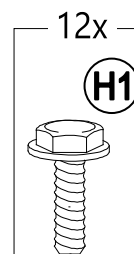
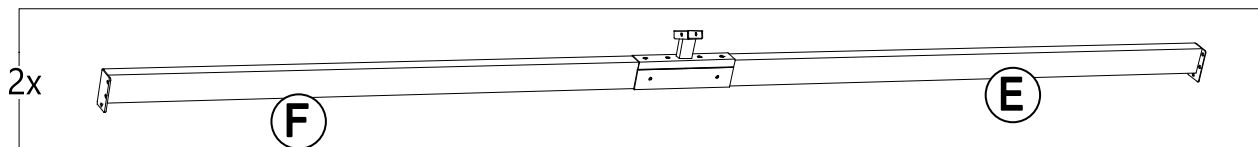

5

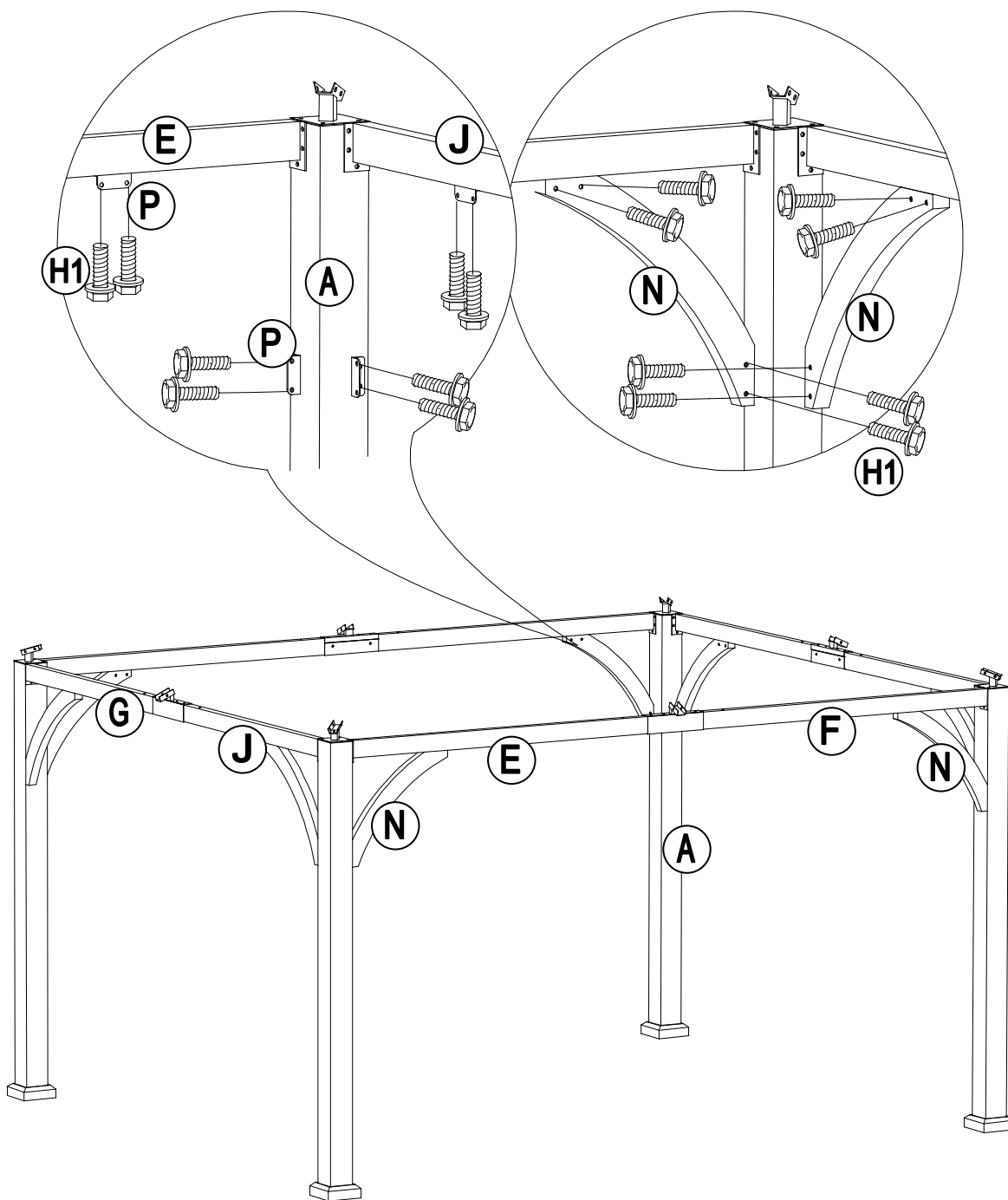
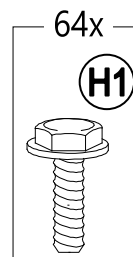
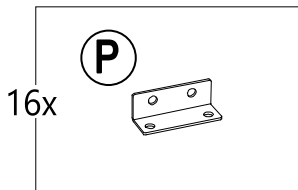
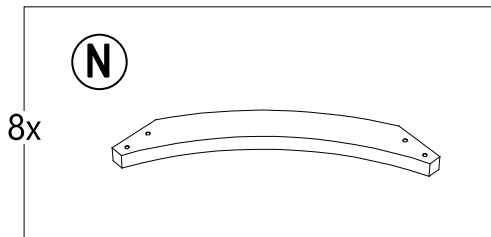

6

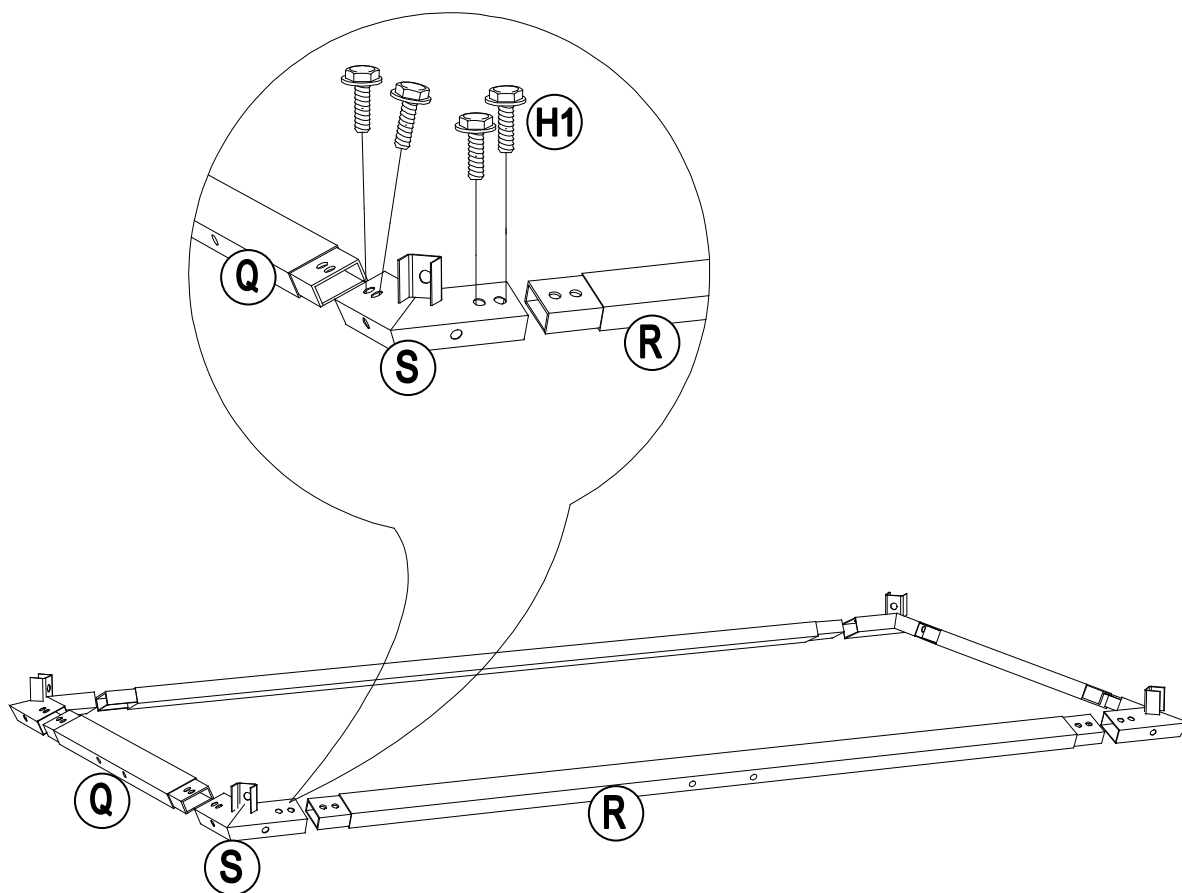
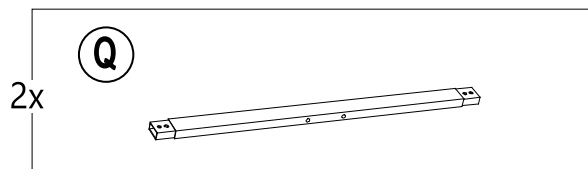
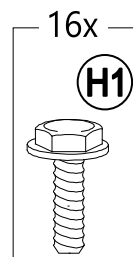
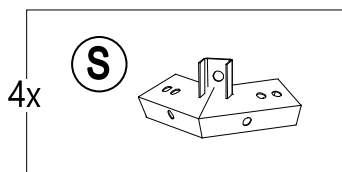
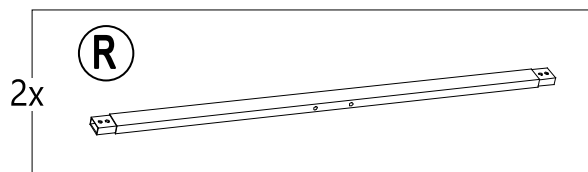

7

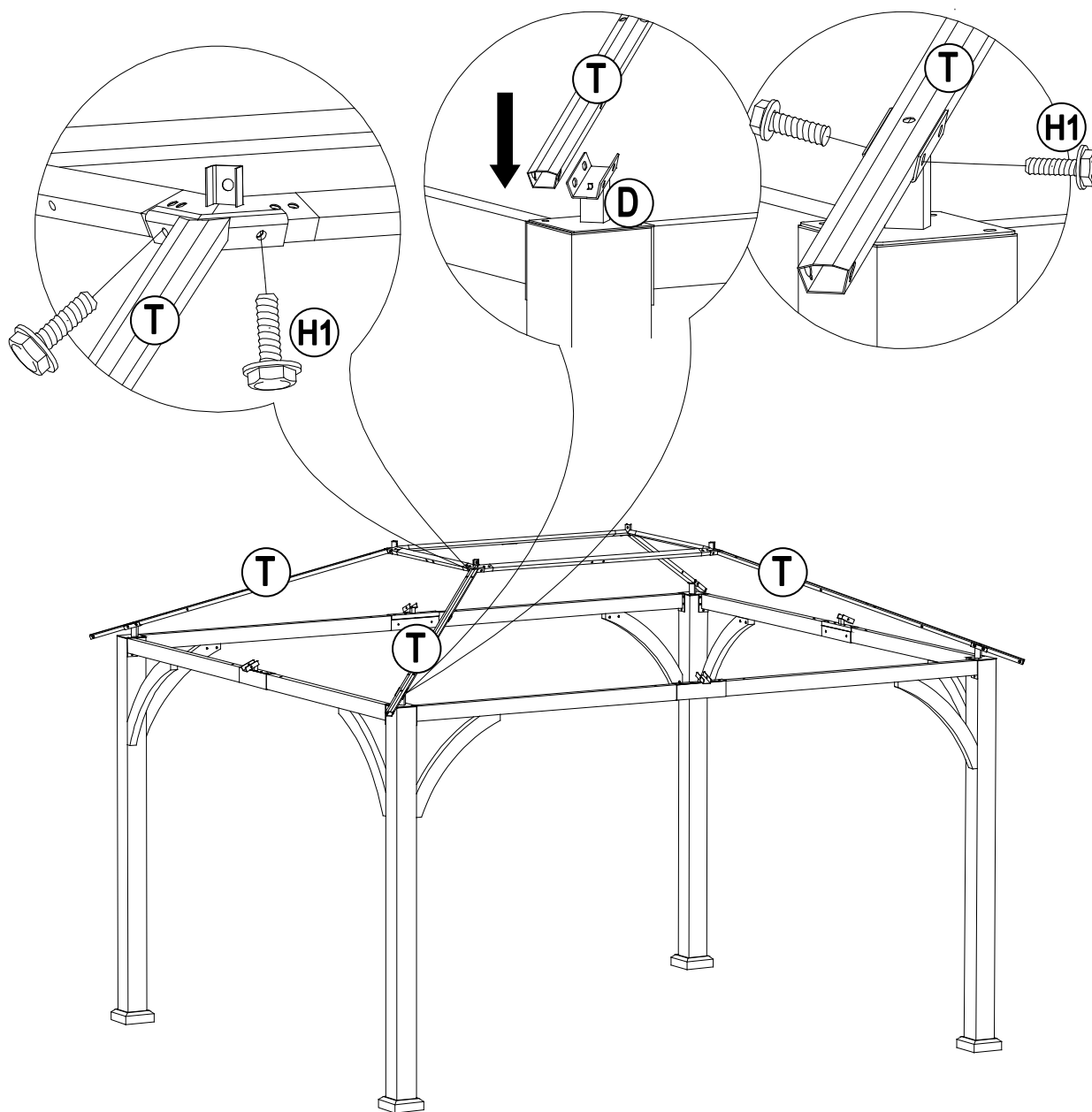
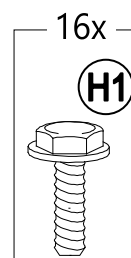
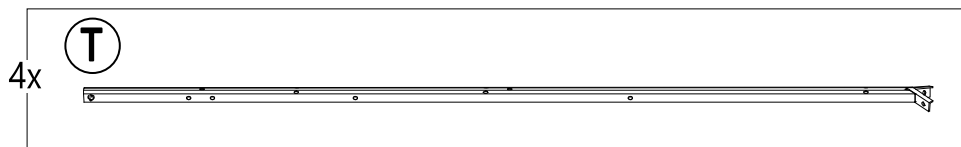

8

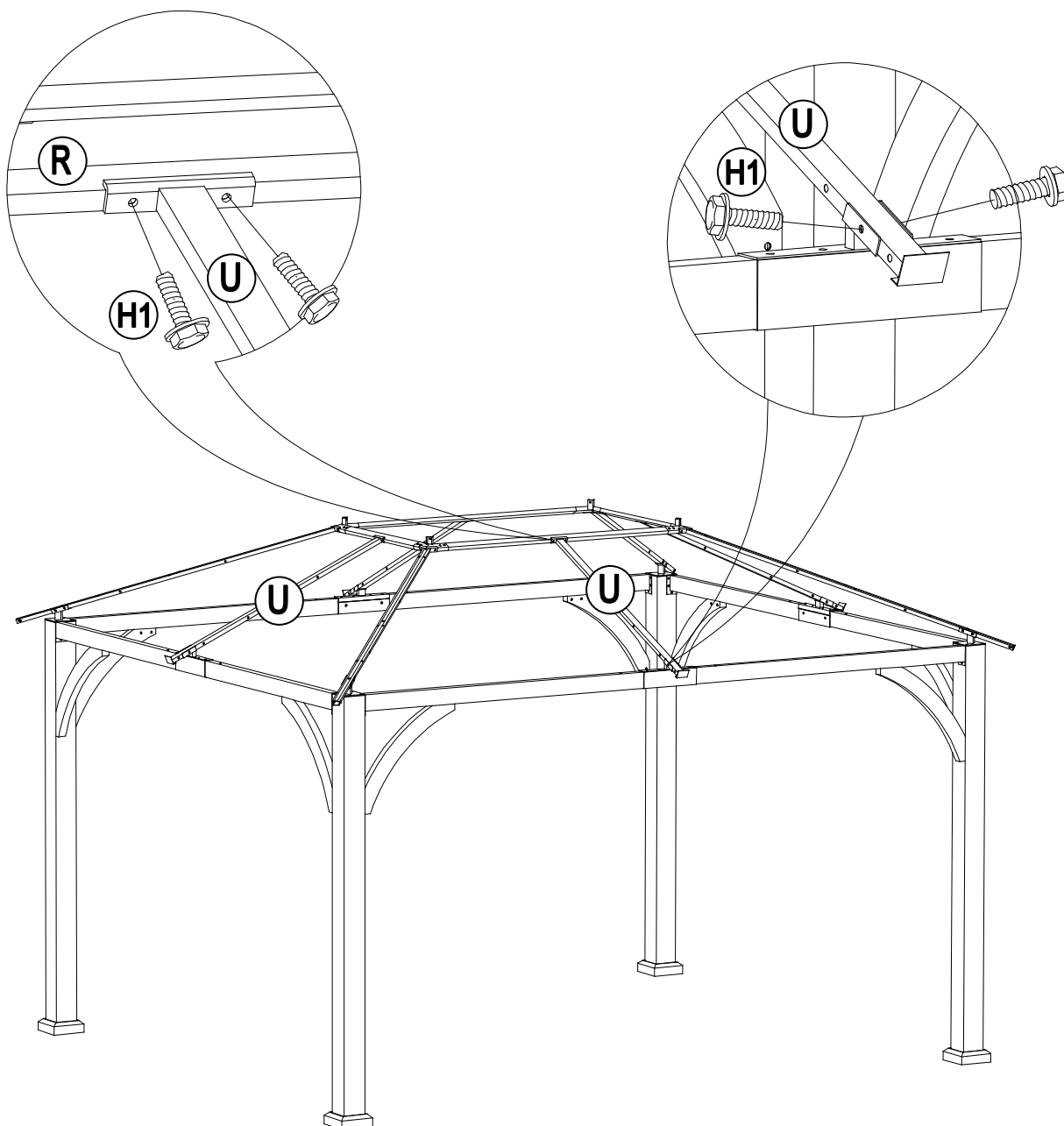
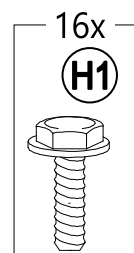
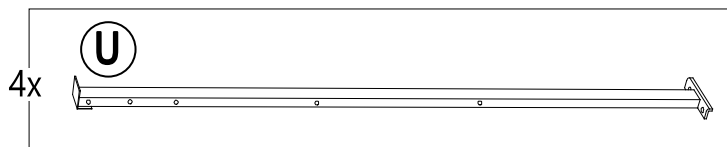

9

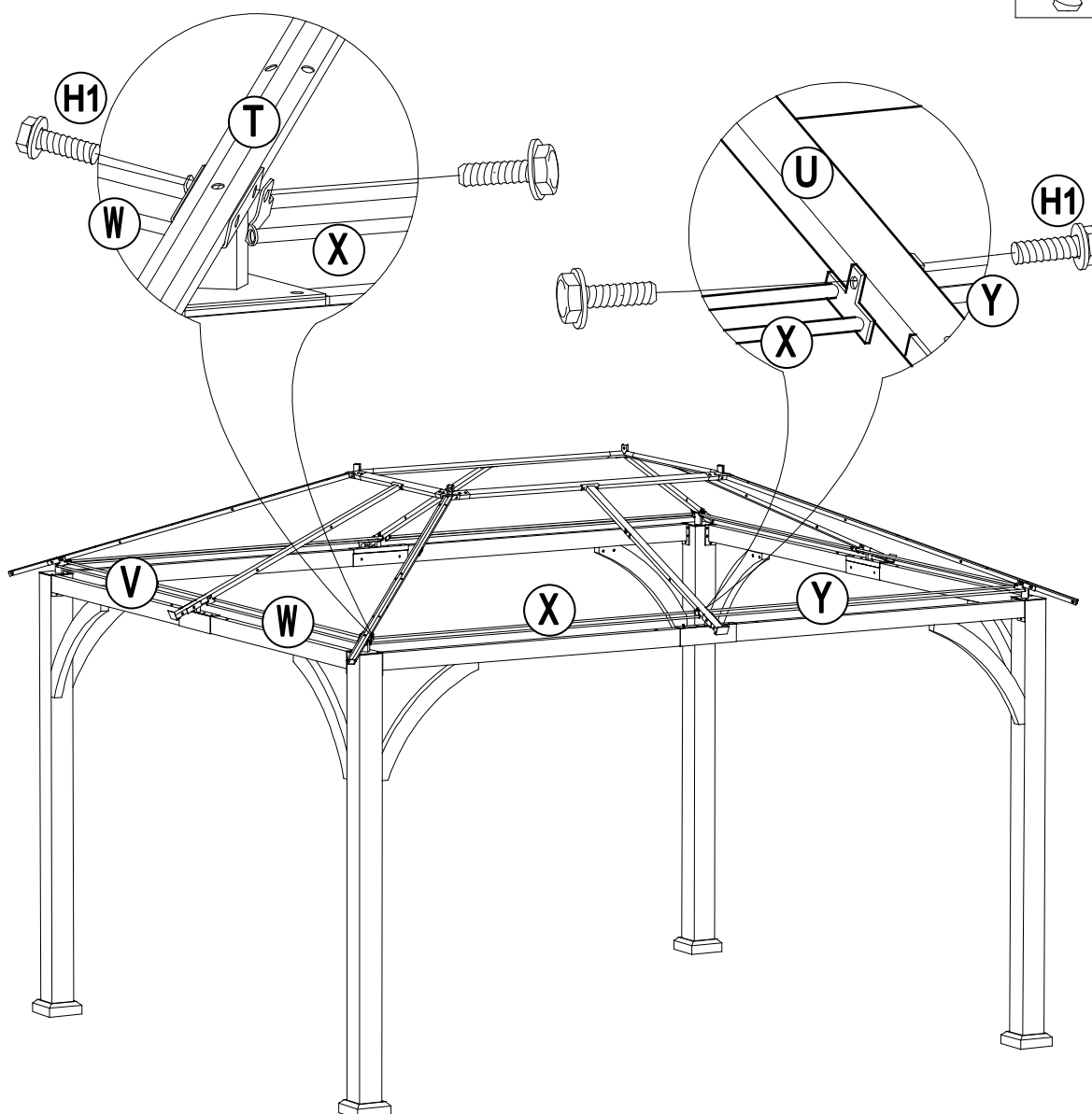
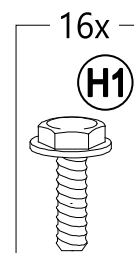
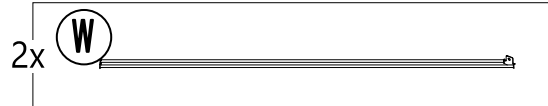
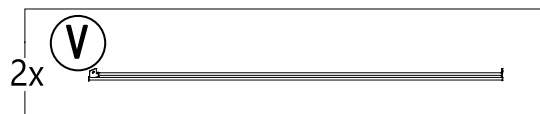
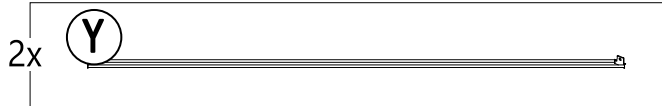
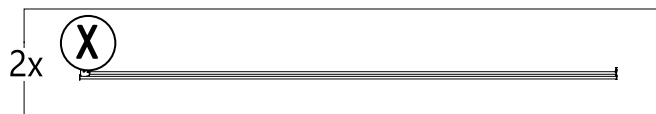

10

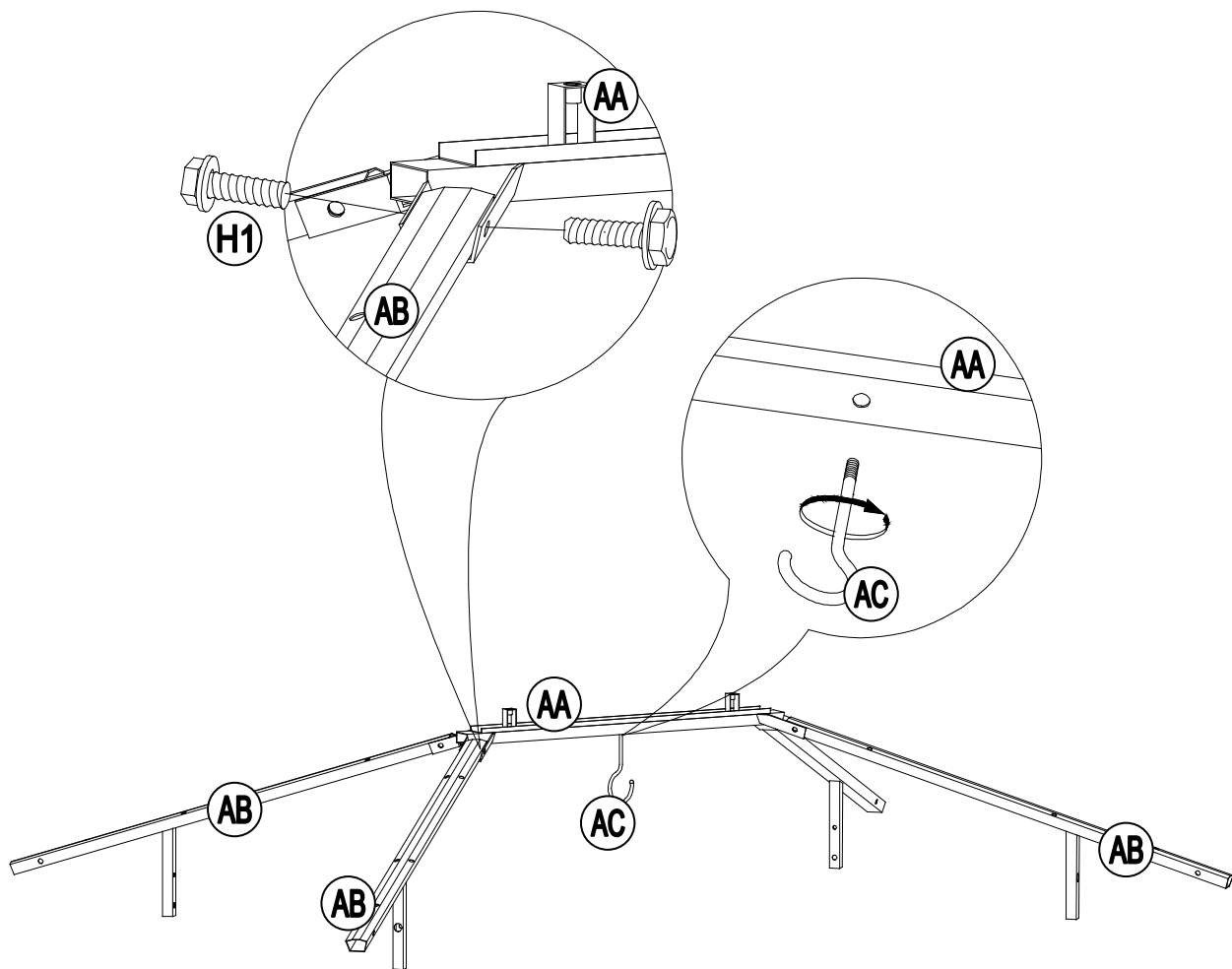
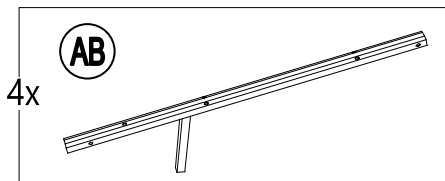
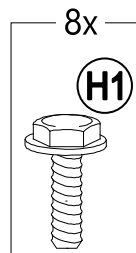
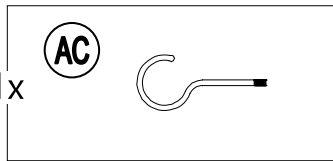
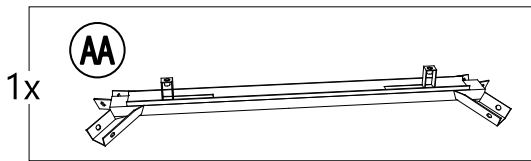

11

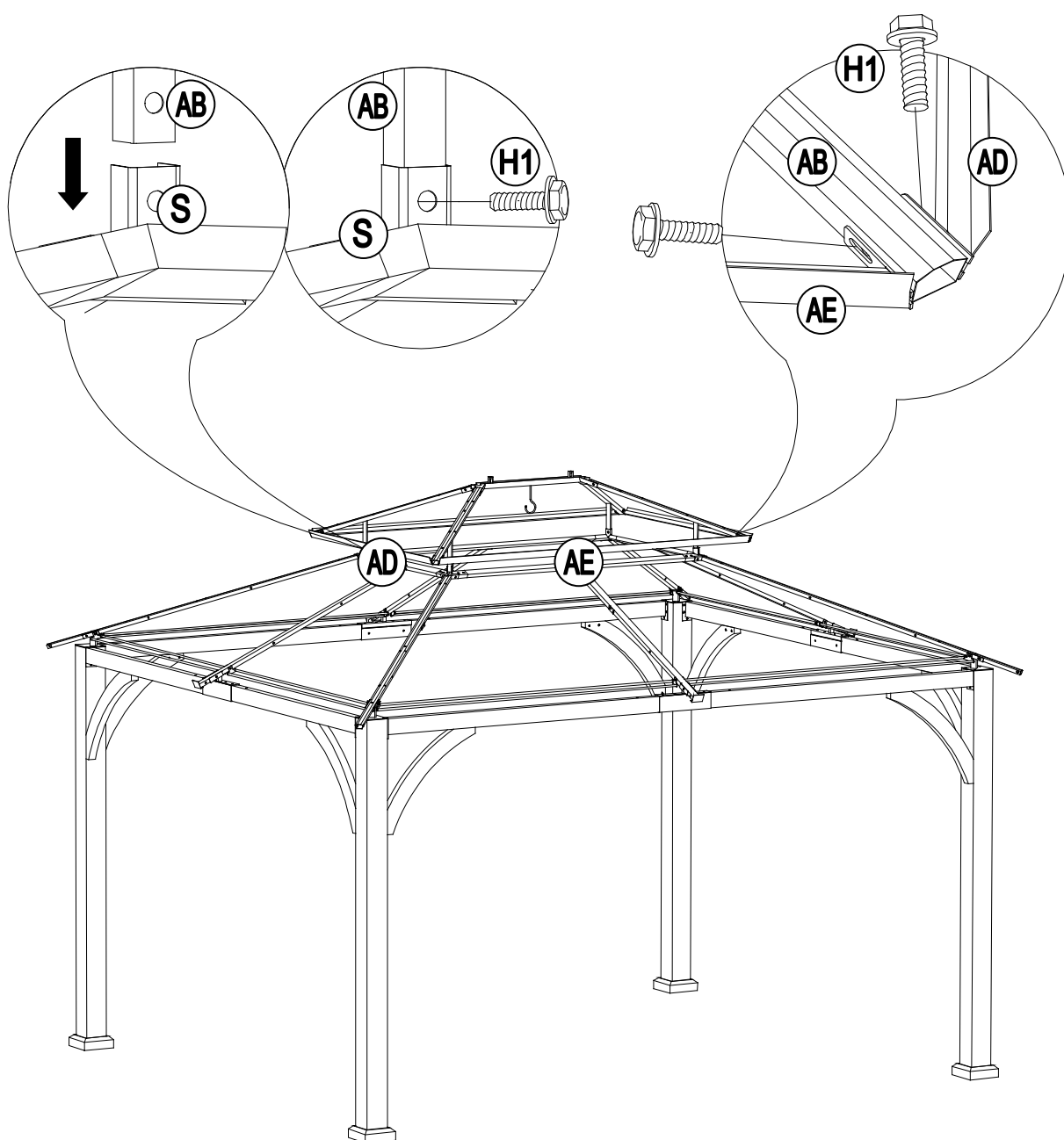
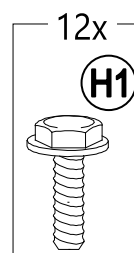
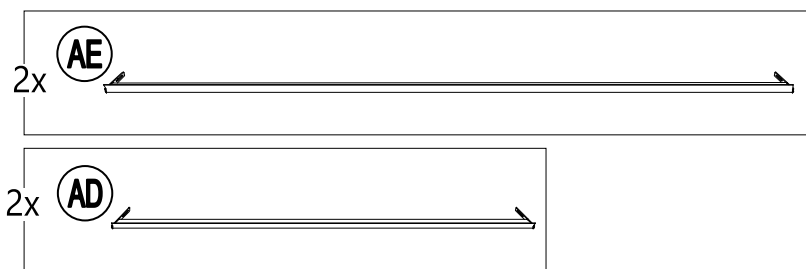

12

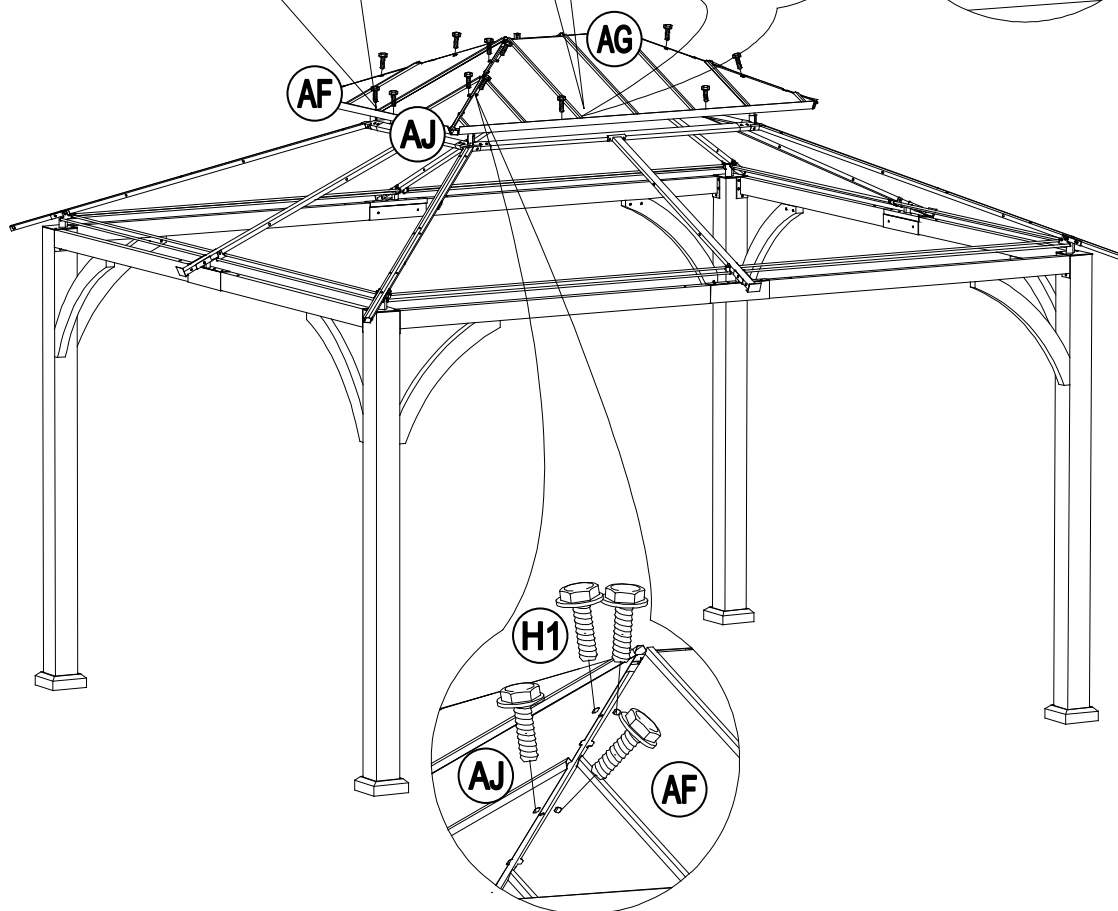
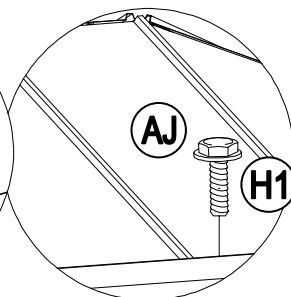
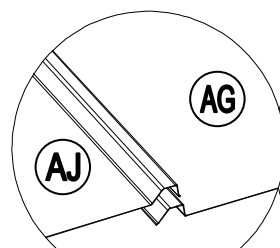
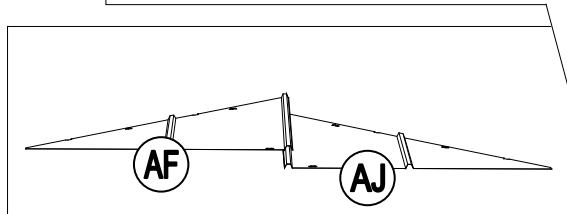
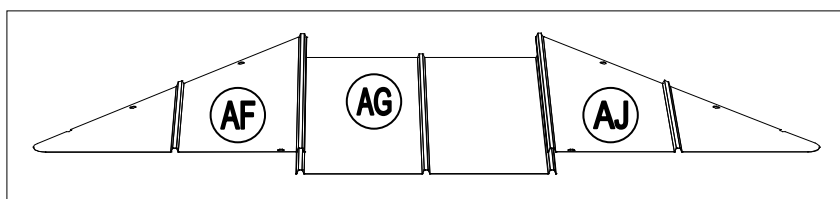
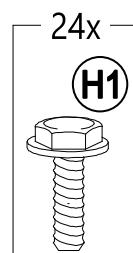
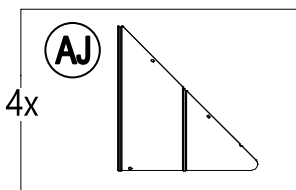
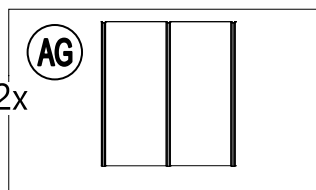
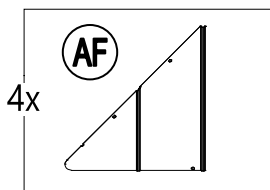

13

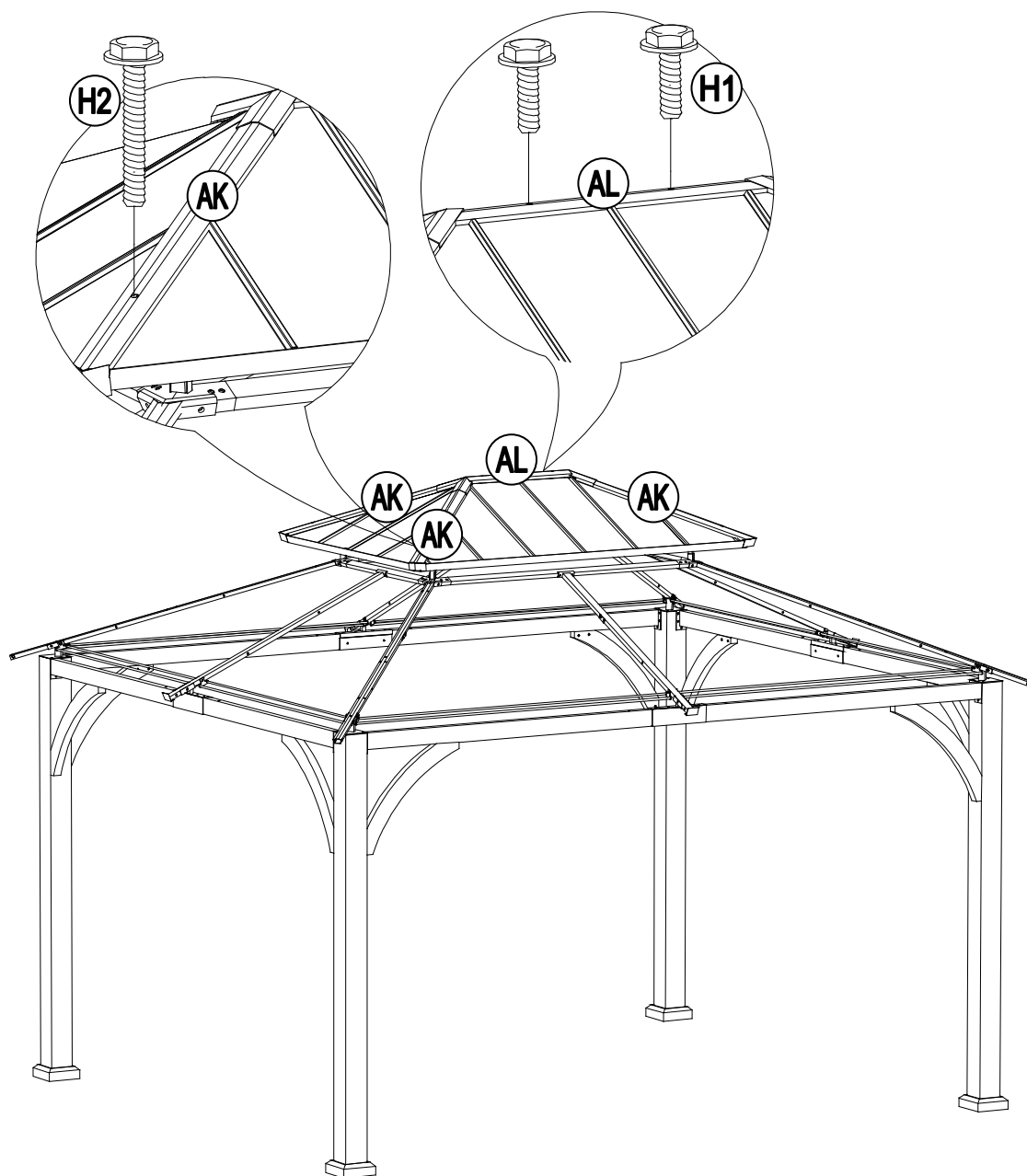
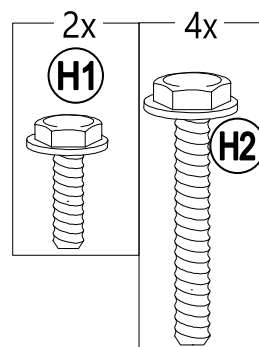
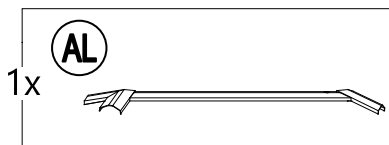
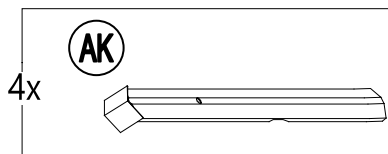

14

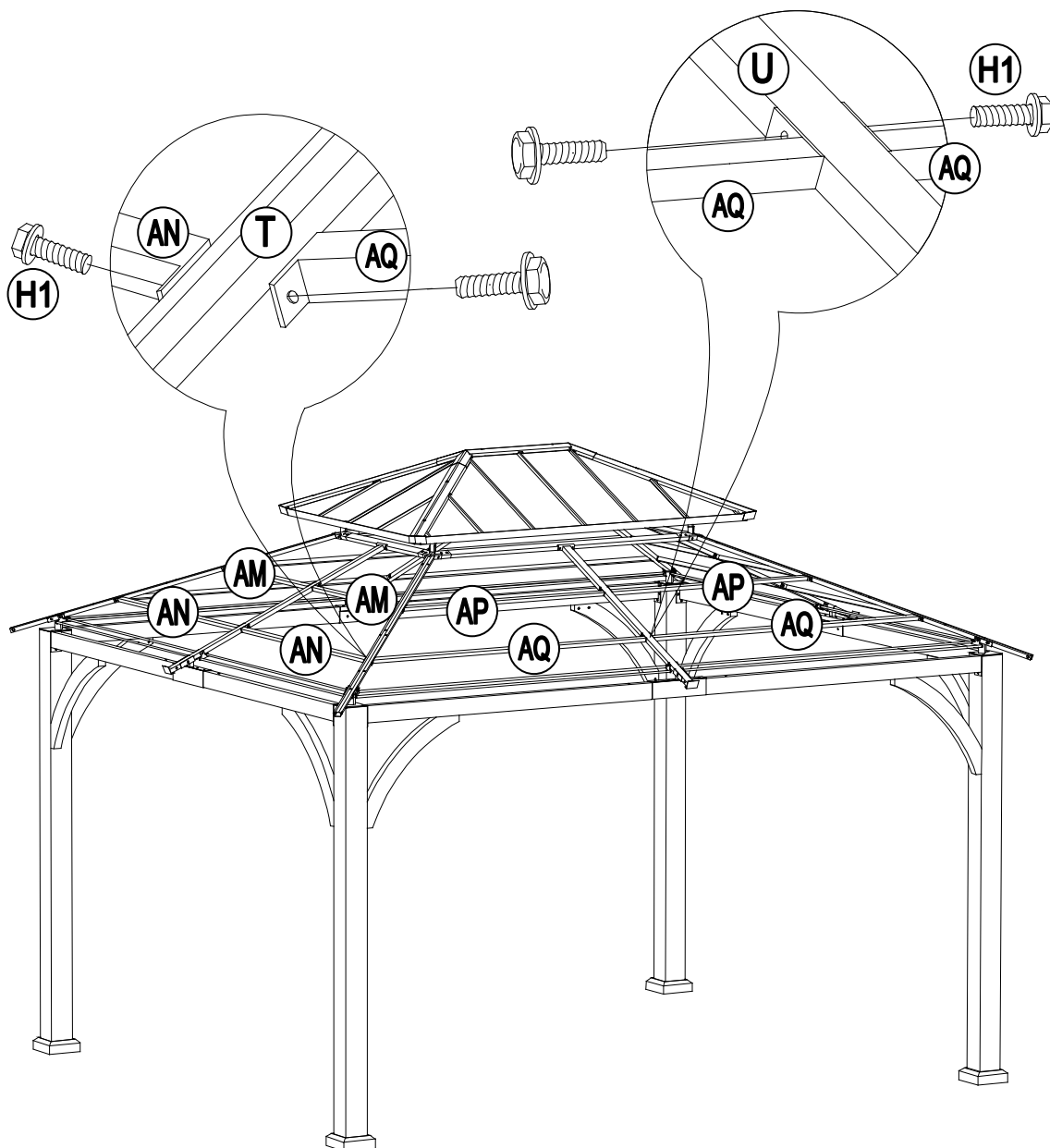
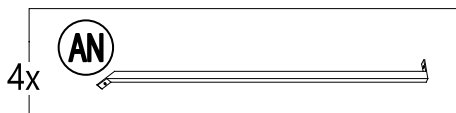
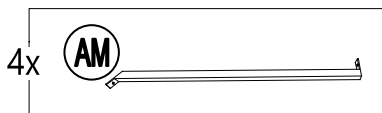
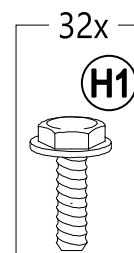
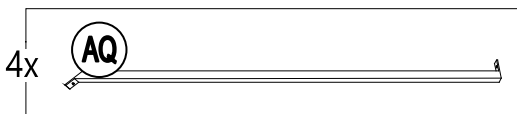
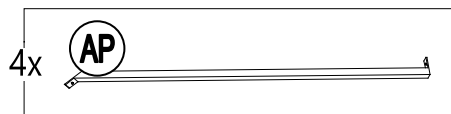

15

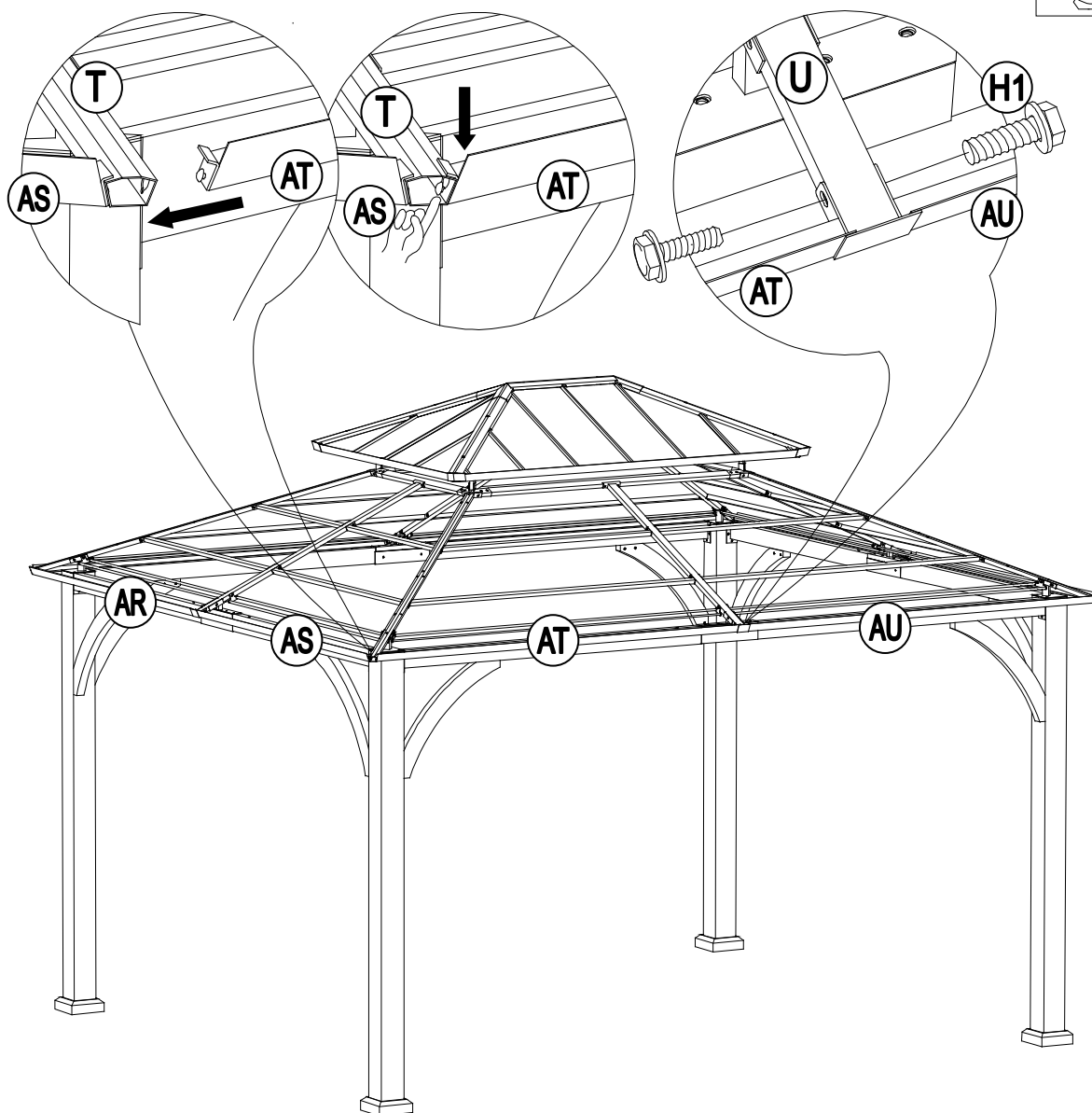
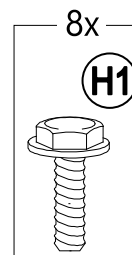
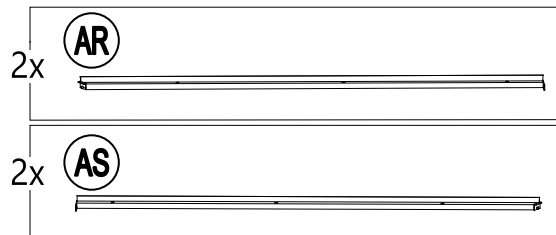
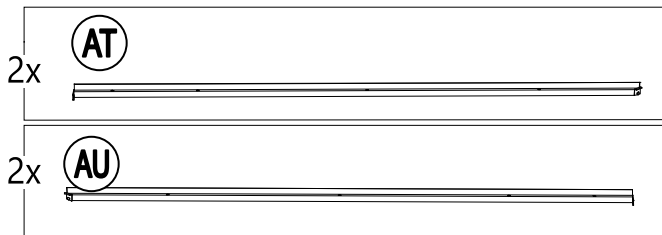

16

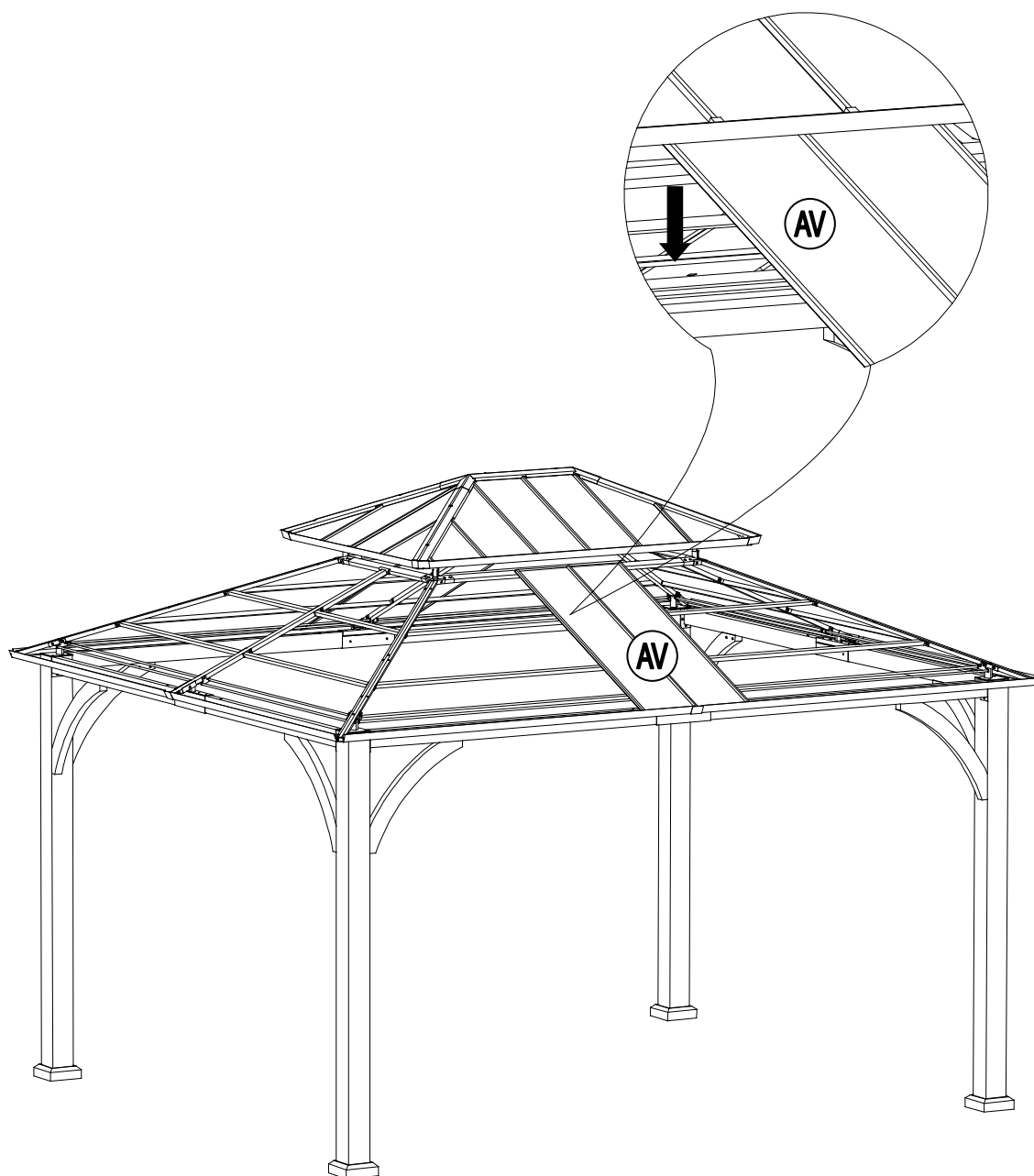
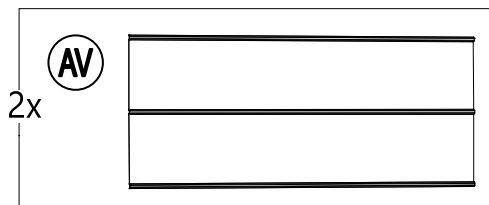

17

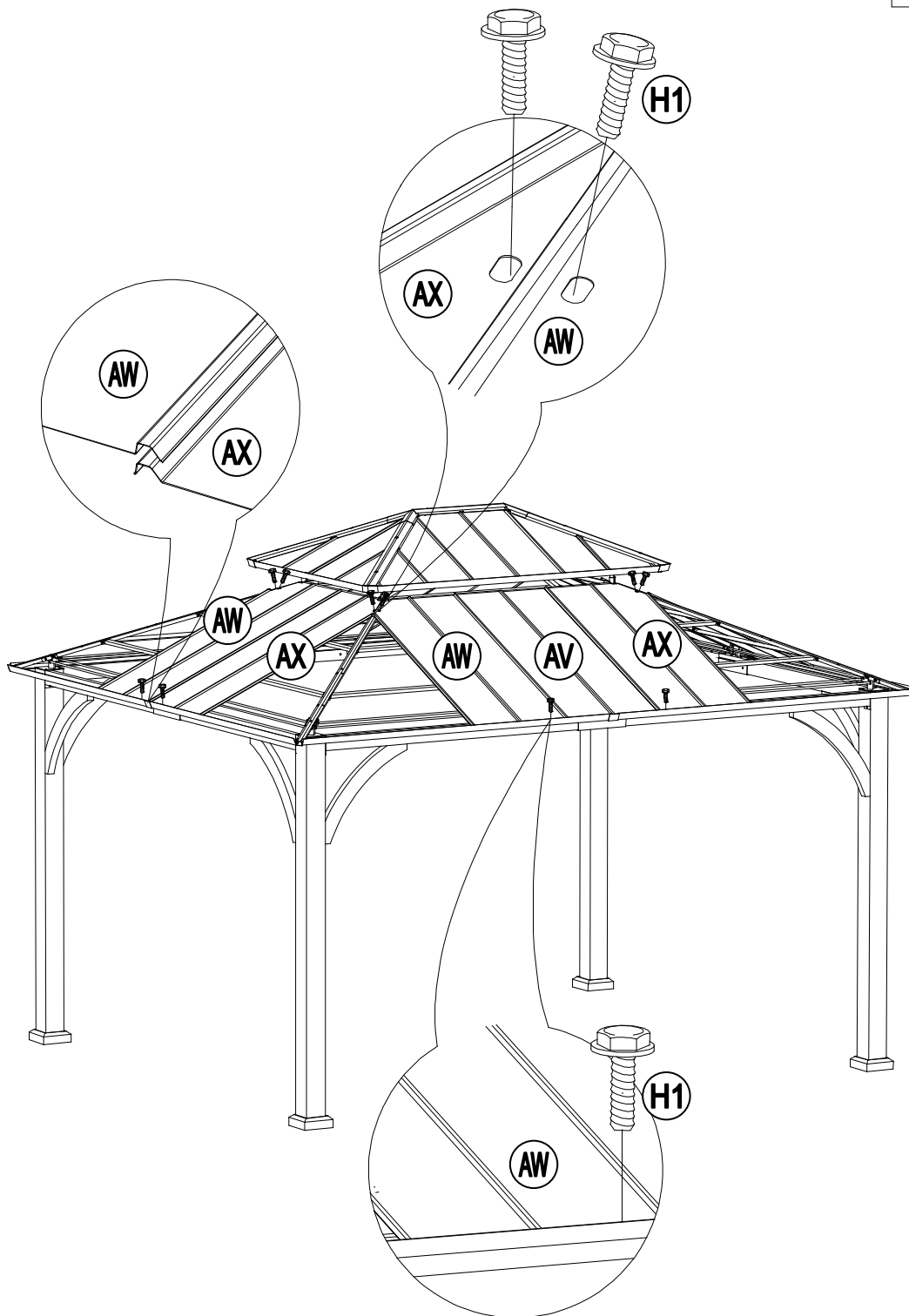
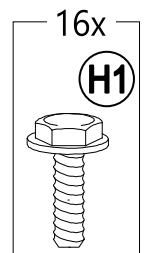

18

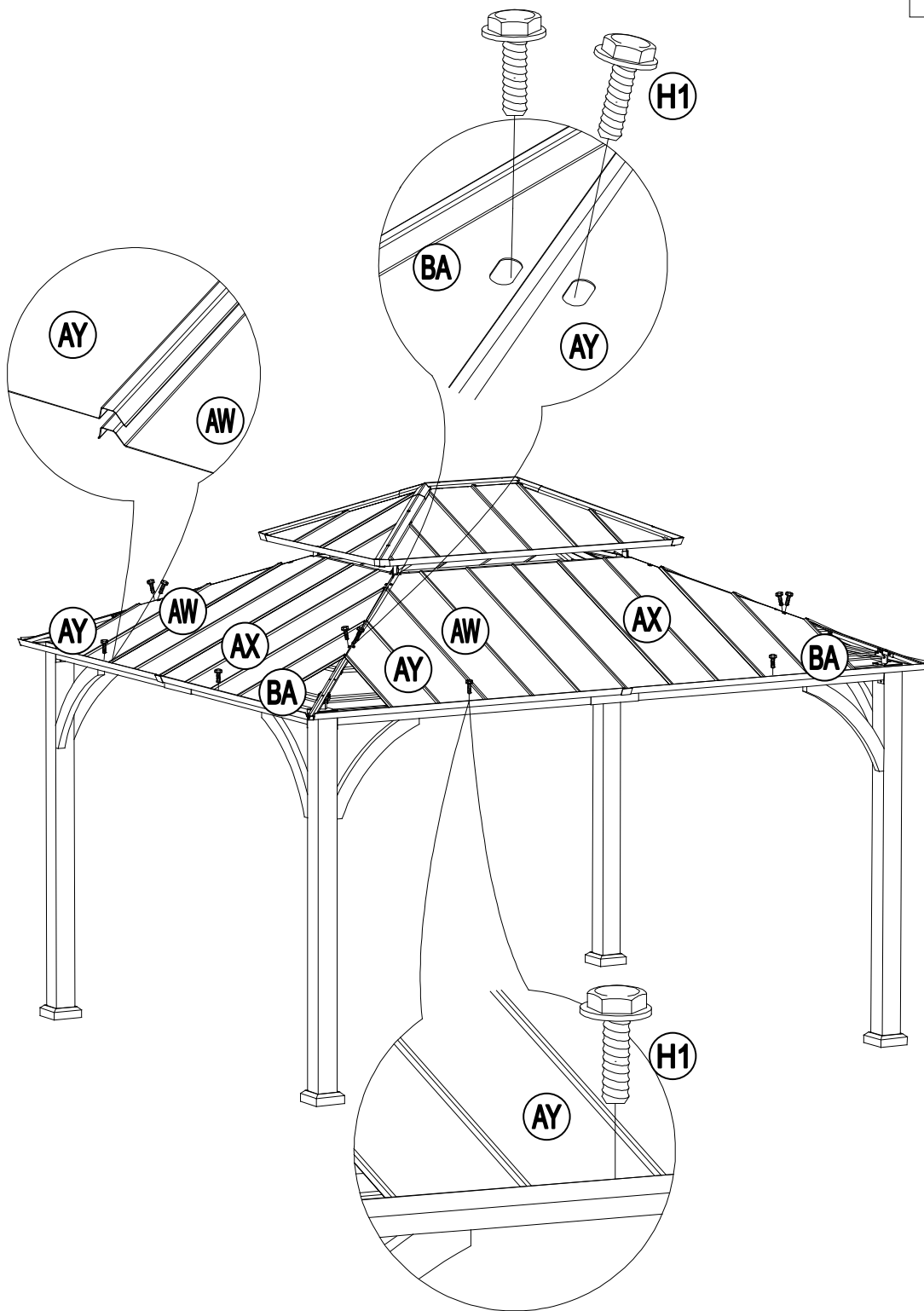
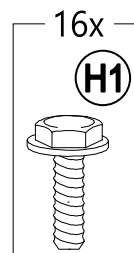
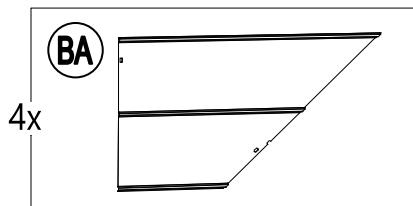
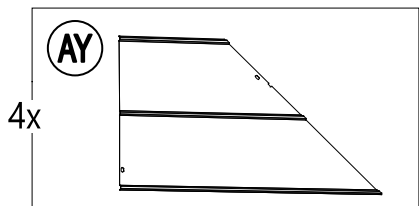

19

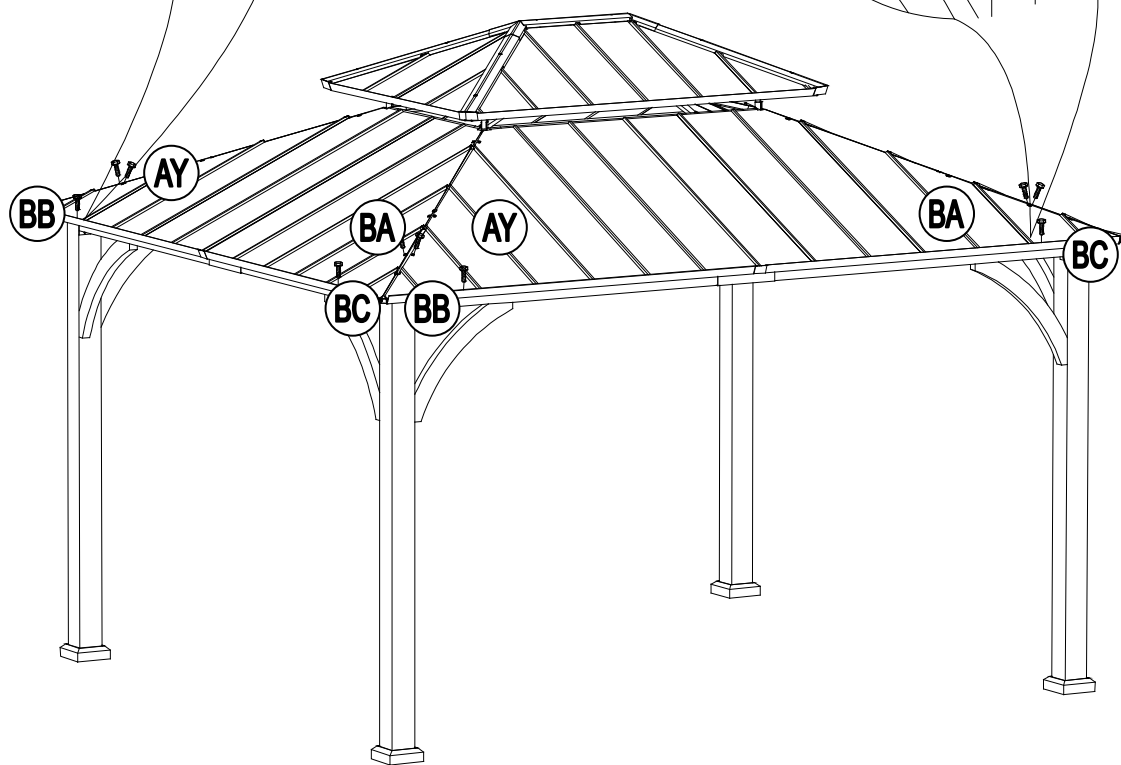
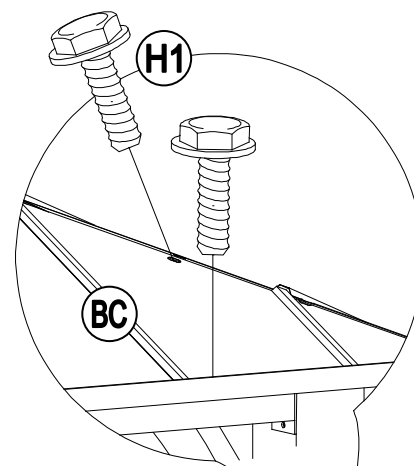
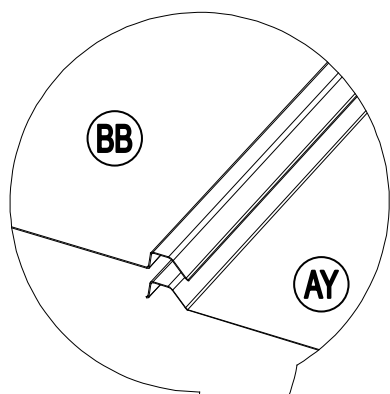
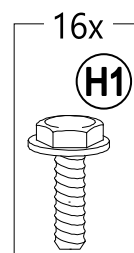
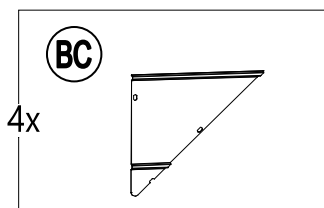
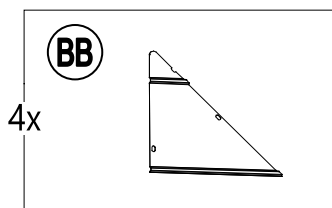

20

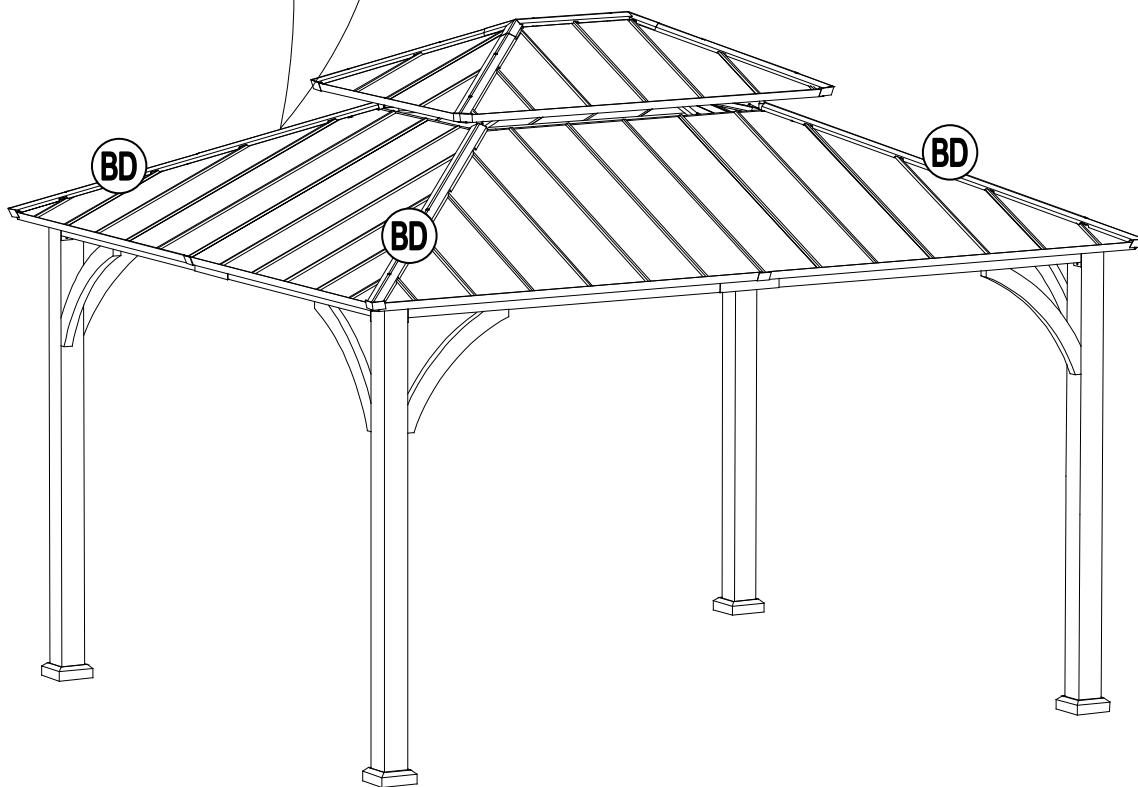
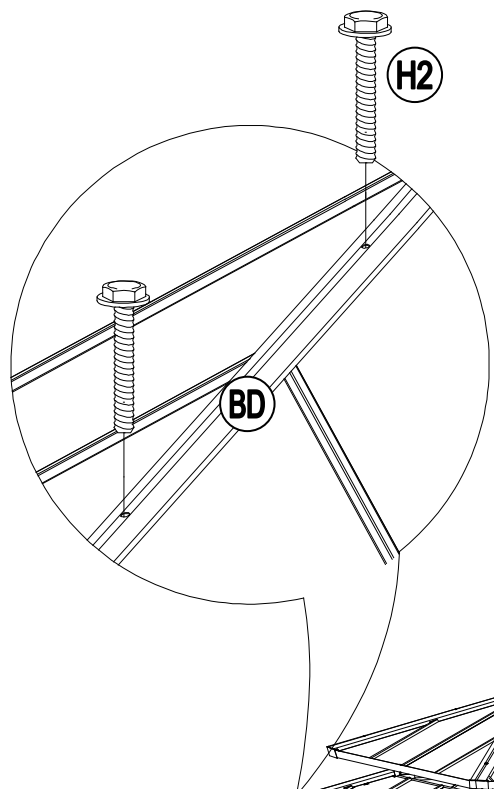
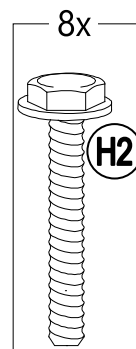
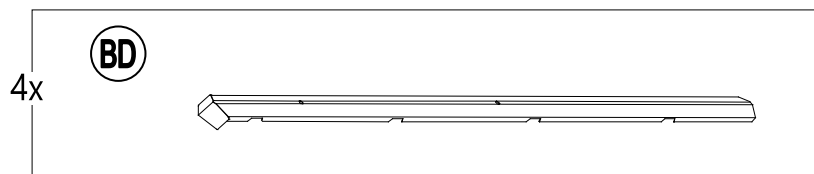

21

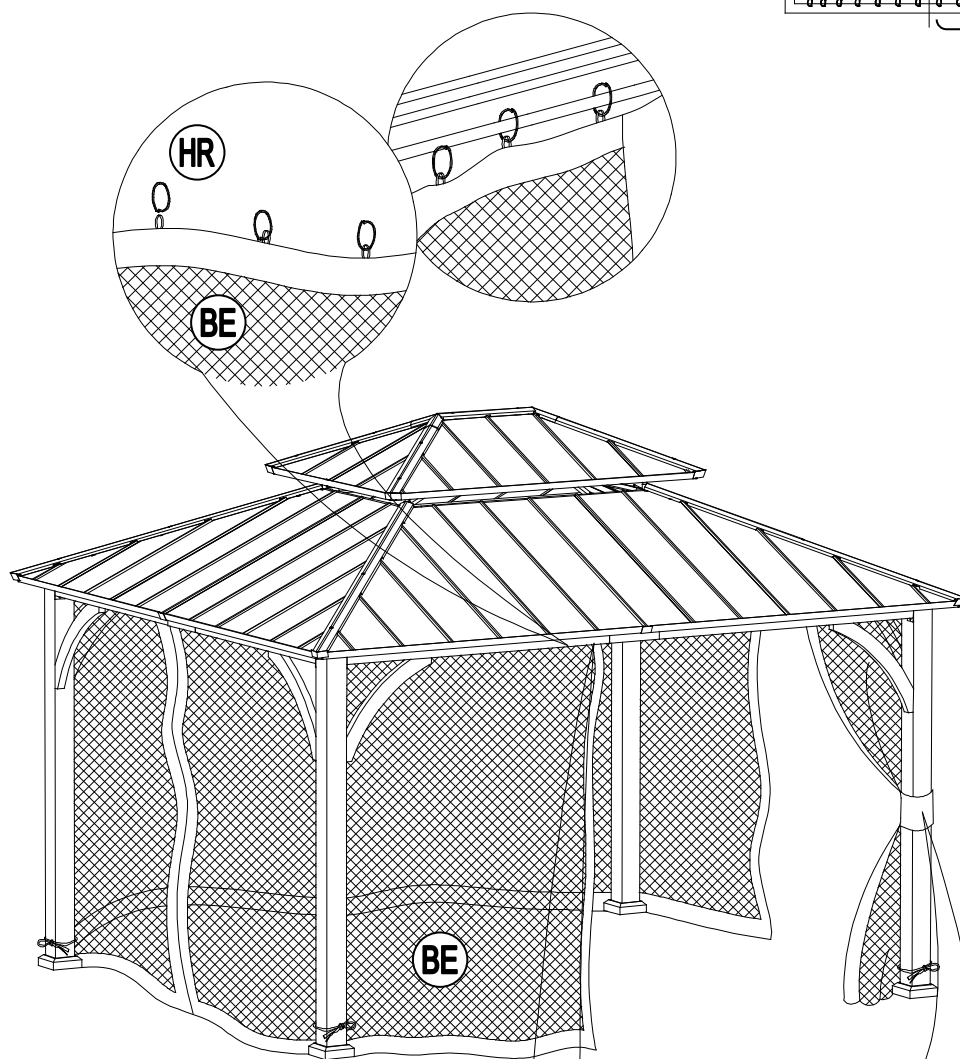
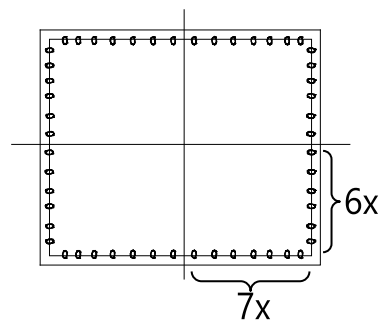
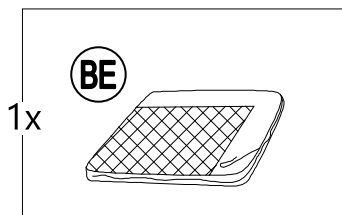

Please match the zippers for different panels as shown in picture

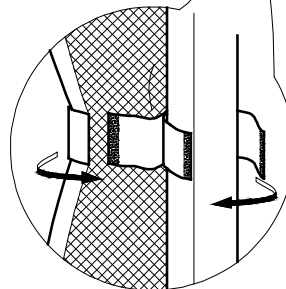
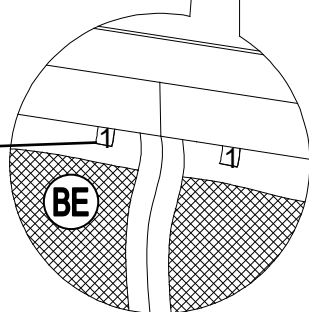

22

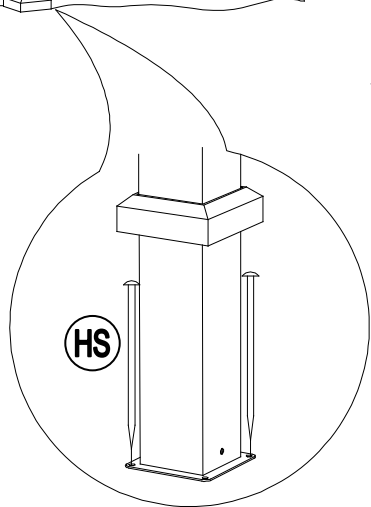
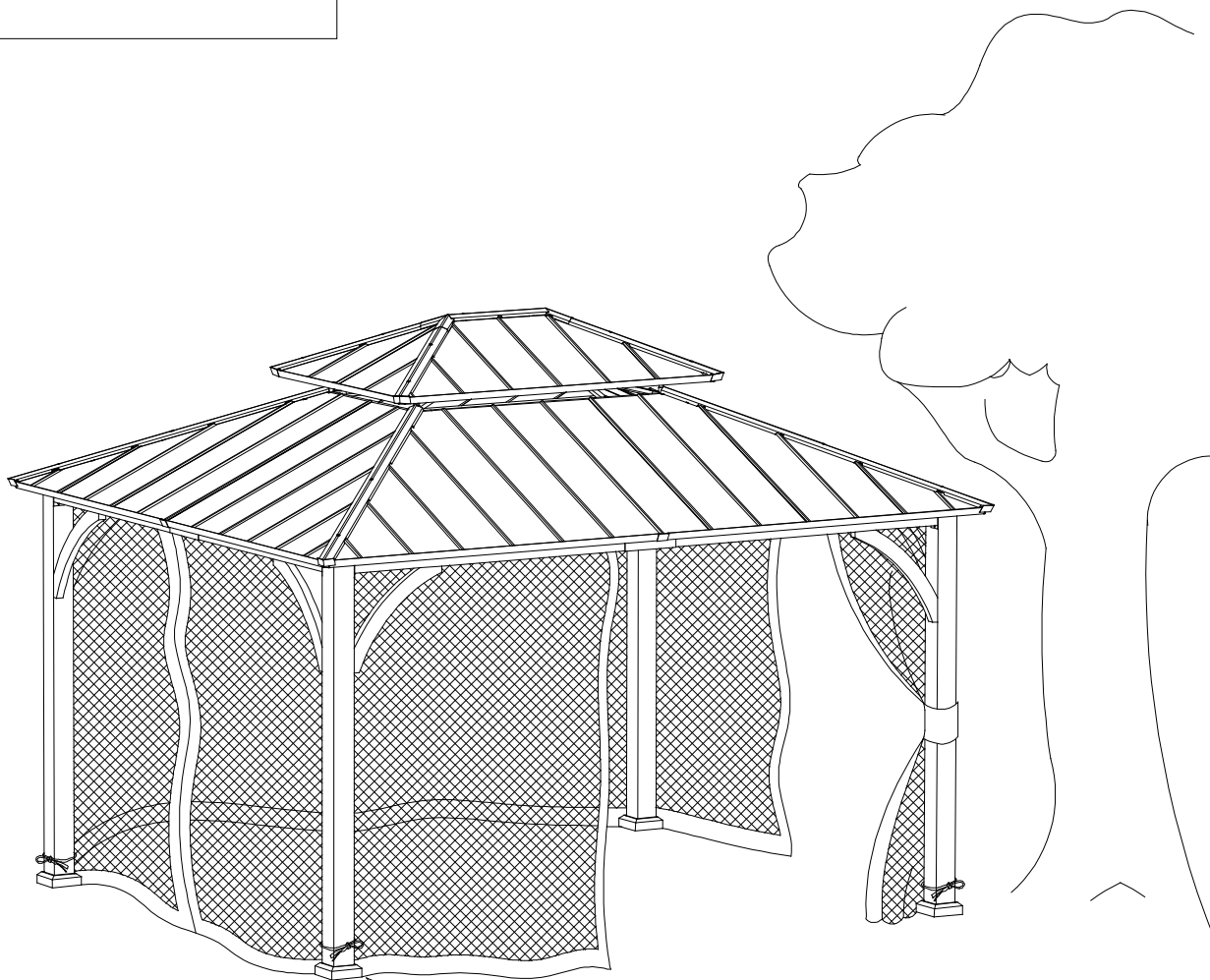
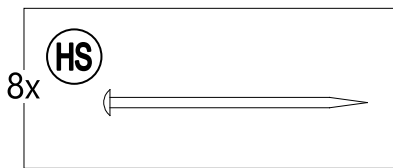

Cleaning and Maintenance

Caution!

- Check all screws and nuts periodically for tightness, fastening them again as required.
- Disassemble the gazebo in the reverse order of the assembly steps. Always disassemble the gazebo completely. A partially disassembled gazebo is not stable enough to resist wind and bad weather, and therefore can be damaged and/or cause damage.
- Clean the gazebo with mild soap and water. Rinse thoroughly, and wait until the product is dry before reassembling it.
- Snow must be cleared off regularly during snowy days. Remove the snow at the roof top when it is thicker than 2 inches. In order to avoid damage, use a plastic snow rake to remove excessive snow and ice buildup from roof and keep away from falling debris.
- Do not use bleach, acid, or other abrasive cleaners on the canopies or frame parts.
- Steel components for this gazebo are treated with rust inhibiting paint. However, due to the nature of steel, surface oxidation (rusting) will occur if these protective coatings are scratched. This is not a defect and thus not covered by the warranty, To minimize this condition, it is recommended to use care when assembling and handling the product to prevent scratching the paint. Should any scratching or damage occur, it is recommended to cover the scratch immediately with rust inhibiting paint (not included) . Surface rust can also be easily removed with a very light application of regular cooking oil or WD-40. If surface oxidation (rusting) occurs and if no measure is taken to prevent this, the oxidation may start dripping onto deck or patio and caused damaging stains, which may be difficult to remove. This can be prevented if the above-mentioned measures at taken to keep the product from oxidizing.
- Keep instruction manual for future reference.
- Keep the original packaging to store the gazebo.

Warranty

Carefully check all packaging materials before discarding. Do not assemble if there are missing pieces. For comments or questions please contact BJ's Wholesale Club at 1-800-934-1204.

Please do not return this product to the store. For technical assistance on assembly or replacement parts call Sunjoy Group at 1(866) 578-6569 anytime 24 hour /7 days a week or Email bj@sunjoygroup.com or visit www.sunjoyonline.com to place your order or fax your parts replacement order form together with your purchase receipt to 951-667-3447 for assistance.

Production Number: 2021100351